

# Servomotors

## NK Series

Technical Manual

PVD 3664\_GB



## EU DECLARATION OF CONFORMITY

We ,

**Parker Hannifin Manufacturing France SAS**  
**Electric Motion & Pneumatic Division**  
**Etablissement de Longvic**  
**4 Boulevard Eiffel - CS40090**  
**21604 LONGVIC Cedex - France**

manufacturer, with brand name **Parker**, declare under our sole responsibility that the products

### **SERVOMOTORS TYPE NK**

satisfy the arrangements of the directives :

**Directive 2014/35/EU : “Low Voltage Directive”, LVD**  
**Directive 2011/65/EU + delegated Directive (EU) 2015/863: RoHS 3 “Restriction of Hazardous Substances”**  
**Directive 2014/30/EU : “Electromagnetic Compatibility”, EMC**

and meet standards or normative document according to :

**IEC 60034-1:2017 : Rotating electrical machines - Part 1 : Rating and performance.**  
**IEC 60034-5:2020 : Rotating electrical machines - Part 5 : Degrees of protection provided by the integral design of rotating electrical machines (IP code) - Classification.**  
**IEC 60204-1:2016 : Safety of machinery – Electrical equipment of machines – Part 1 : General requirements.**

The product itself is not impacted by the modifications made on the latest directives.

The undersigned certify that the above mentioned model is procured in accordance with the above directives and standards.

Further information :

**SERVOMOTORS shall be mounted on a mechanical support providing good heat conduction and not exceeding 40° C in the vicinity of the motor flange.**

**As NK is a kit motor, final conformance of the complete motor is under the responsibility of the integrator.**

The product must be installed in accordance with the instructions and recommendations contained in the operating instructions supplied with the product.

NK1 C.E. Marking : March 2005  
NK2 C.E. Marking : October 2003  
NK3 C.E. Marking : November 2001

NK4 C.E. Marking : September 2002  
NK6 C.E. Marking : July 2002  
NK8 C.E. Marking : April 2004

Longvic, June 11<sup>th</sup> 2021

In the name of Parker  
R. WENDLING  
**Business Unit Manager**

Ref : DCE-NK-001rev02

Raphael  
Wendling

Digital unterschrieben von  
Raphael Wendling  
Datum: 2021.06.14 14:46:23  
+02'00'

## Table of Content

<b>1. INTRODUCTION .....</b>	<b>5</b>
1.1. Purpose and intended audience .....	5
1.2. Safety .....	5
1.2.1. Principle .....	5
1.2.2. General Safety Rules .....	6
<b>2. PRODUCT DESCRIPTION .....</b>	<b>7</b>
2.1. Quick URL .....	7
2.2. Overview .....	7
2.3. Applications .....	8
2.4. Motor description .....	10
2.5. General Technical Data .....	10
2.6. Product Code .....	11
<b>3. TECHNICAL DATA .....</b>	<b>12</b>
3.1. Motor selection .....	12
3.1.1. Altitude derating .....	12
3.1.2. Temperature derating .....	12
3.1.3. Thermal equivalent torque (rms torque) .....	14
3.1.4. Drive selection .....	16
3.1.5. Current limitation at stall conditions (i.e. speed < 3 rpm) .....	19
3.1.6. Peak current limitations .....	19
3.2. NK Characteristics: Torque, speed, current, power .....	20
3.2.1. NK data with natural cooling – Mains voltage 230V .....	21
3.2.2. NK data with natural cooling – Mains voltage 400V .....	22
3.2.3. NK data with water cooling – Mains voltage 400V .....	22
3.2.4. Further Data with natural cooling .....	23
3.2.5. Further Data with water cooling .....	24
3.2.6. Efficiency curves .....	25
3.2.7. Electromagnetic losses .....	32
3.2.8. Time constants of the motor .....	33
3.2.9. Speed ripple .....	35
3.2.10. Cogging torque .....	35
3.2.11. Rated data according to rated voltage variation .....	36
3.2.12. Voltage withstand characteristics of NK series .....	38
3.3. Dimension drawings .....	39
3.3.1. NK3 .....	39
3.3.2. NK4 .....	40
3.3.3. NK6 .....	41
3.3.4. NK8 .....	42
3.3.1. NK3.W .....	43
3.3.2. NK4.W .....	44
3.3.3. NK6.W .....	45
3.3.4. NK8.W .....	46
3.4. Motor mounting recommendations .....	47
3.4.1. Frame recommendation .....	47
3.4.2. Servomotor typical construction .....	48
3.4.3. Bearings recommendation .....	48
3.4.4. Mechanical interfaces .....	49
3.4.5. Water cooled version recommendations .....	52
3.4.6. Design Compliance .....	53
3.4.7. Dielectric test .....	53
3.4.8. Earthing .....	53
3.4.9. Minimum clearances for insulation and creepage distances .....	53
3.4.10. Ground continuity compliance .....	54
3.4.11. Protection rating .....	54
3.4.12. Overspeed test .....	55
3.4.13. EMC Directive .....	55
3.4.14. Other requirements .....	55
3.5. Cooling .....	56
3.5.1. Natural and fan cooled motor .....	56

3.5.2.	Water cooled motor .....	57
3.5.3.	Additives for water as cooling media .....	58
3.5.4.	Motor cooling circuit drop pressure .....	59
3.5.5.	Chiller selection .....	59
3.5.6.	Flow derating according to glycol concentration .....	60
3.5.7.	Water cooling diagram.....	62
3.6.	Thermal Protection .....	64
3.6.1.	Alarm tripping with PTC thermistors : .....	64
3.6.2.	Temperature measurement with KTY sensors:.....	65
3.7.	Power Electrical Connections .....	66
3.7.1.	Wires sizes .....	66
3.7.2.	Conversion Awg/kcmil/mm <sup>2</sup> :.....	67
3.7.3.	Motor cable length .....	68
3.7.4.	Ground connection .....	68
3.7.5.	Motor cable .....	68
3.8.	Feedback system .....	69
3.8.1.	Resolver .....	69
3.8.2.	Encoder .....	74
<b>4.</b>	<b>COMMISSIONING, USE AND MAINTENANCE .....</b>	<b>75</b>
4.1.	Instructions for commissioning, use and maintenance .....	75
4.1.1.	Equipment delivery .....	75
4.1.2.	Handling .....	75
4.1.3.	Storage .....	75
4.2.	Machine Integration.....	76
4.2.1.	General warnings .....	76
4.2.2.	Tightening torque.....	78
4.2.3.	Rotor integration step by step .....	79
4.2.1.	Natural cooled stator integration step by step .....	81
4.2.2.	Water cooled stator integration step by step .....	83
4.2.3.	Motor integration.....	84
4.3.	Resolver mounting .....	90
4.3.1.	Mounting step by step .....	90
4.3.2.	Setting of the resolver.....	91
4.4.	Electrical connections .....	92
4.5.	Encoder cable handling.....	94
4.6.	Tests.....	95
4.7.	Troubleshooting .....	96

## 1. INTRODUCTION

### 1.1. Purpose and intended audience

This manual contains information that must be observed to select, install, operate and maintain PARKER NK servomotors.

The design, tests, certification, commissioning, operation and maintenance of the equipment should be carried out by qualified personnel. A qualified person is someone who is technically competent and familiar with all safety information and established safety practices; with the installation process, operation and maintenance of this equipment; and with all the hazards involved.

Reading and understanding the information described in this document is mandatory before carrying out any operation on the motors. If any malfunction or technical problem occurs, that has not been dealt with in this manual, please contact PARKER for technical assistance. In case of missing information or doubts regarding the installation procedures, safety instructions or any other issue tackled in this manual, please contact PARKER as well.

PARKER's responsibility is limited to its servomotors and does not encompass the whole user's system. Data provided in this manual are for product description only and may not be guaranteed, unless expressly mentioned in a contract.



**DANGER:** PARKER declines responsibility for any accident or material damage that may arise, if the procedures and safety instructions described in this manual are not scrupulously followed.

### 1.2. Safety





#### 1.2.1. Principle

To operate safely, this equipment must be transported, stored, handled, installed and serviced correctly. Following the safety instructions described in each section of this document is mandatory. Servomotors usage must also comply with all applicable standards, national directives and factory instructions in force.



**DANGER:** Non-compliance with safety instructions, legal and technical regulations in force may lead to physical injuries or death, as well as damages to the property and the environment.

### 1.2.2. General Safety Rules

	<p><b>Generality</b>  <b>DANGER:</b> The installation, commission and operation must be performed by qualified personnel, in conjunction with this documentation.</p> <p>The qualified personnel must know the safety (C18510 authorization, standard VDE 0105 or IEC 0364) and local regulations.</p> <p>They must be authorized to install, commission and operate in accordance with established practices and standards.</p>
	<p><b>Electrical hazard</b>  Servo drives may contain non-insulated live AC or DC components. Respect the drives commissioning manual. Users are advised to guard against access to live parts before installing the equipment.</p> <p>Some parts of the motor or installation elements can be subjected to dangerous voltages, when the motor is driven by the inverter , when the motor rotor is manually rotated, when the motor is driven by its load, when the motor is at standstill or stopped.</p> <p>For measurements use only a meter to IEC 61010 (CAT III or higher). Always begin using the highest range. CAT I and CAT II meters must not be used on this product.</p> <p>Allow at least 5 minutes for the drive's capacitors to discharge to safe voltage levels (&lt;50V). Use the specified meter capable of measuring up to 1000V dc &amp; ac rms to confirm that less than 50V is present between all power terminals and between power terminals and earth.</p> <p>The motor must be permanently connected to an appropriate safety earth. The continuity of the grounding circuit has to be checked on the complete circuit : the resistance between any conductive point and the grounding conductor shall not exceed more than 100mΩ.</p> <p>To prevent any accidental contact with live components, it is necessary to check that cables are not damaged, stripped or not in contact with a rotating part of the machine. The work place must be clean, dry.</p> <p>General recommendations :</p> <ul style="list-style-type: none"> <li>- Check the wiring circuit</li> <li>- Lock the electrical cabinets</li> <li>- Use standardized equipment</li> </ul>
	<p><b>Mechanical hazard</b>  Servomotors can accelerate in milliseconds. Running the motor can lead to other sections of the machine moving dangerously. Moving parts must be screened off to prevent operators coming into contact with them. The working procedure must allow the operator to keep well clear of the danger area.</p>
	<p><b>Burning Hazard</b>  Always bear in mind that some parts of the surface of the motor can reach temperatures exceeding 100°C.</p>

## 2. PRODUCT DESCRIPTION

### 2.1. Quick URL

All informations and datas are available on :

<http://www.parker.com/eme/nk>

### 2.2. Overview

The NK frameless servomotor are the active parts of a servo motor: a rotor and a stator. The NK series can not be used alone and must integrated into a complete system to provide a complete servomotor. The design, the construction, the certification and the tests are the responsibility of the integrator.

NK servomotors Series from PARKER is an innovative direct drive solution designed for industrial applications. NK Series brushless servomotors from Parker combine exceptional precision and motion quality, high dynamic performances and very compact dimensions.

A large set of torque / speed characteristics, options and customization possibilities are available, making NK Series servomotors the ideal solution for most servosystems applications.

#### Advantages

- Low cogging
- Compact dimensions and robustness
- High precision
- High motion quality
- High dynamic performances
- Higher stiffness of the system
- Simple, light and compact machine design
- no coupling systems needed
- Global cost reduction
- Increased reliability and reduced maintenance
- Integration assistance

## 2.3. Applications

---

**Medical:** Blood pumps, air pump, radiology tables,...

**Machine tools:** Ancillary axis, spindle, axis...

**Marine Submarine**

**Semiconductor**

**Hand tool:** screwdriver,...

**Packaging machinery**

**Robot applications**

**Special machines**

**Pump**

**Compressor**

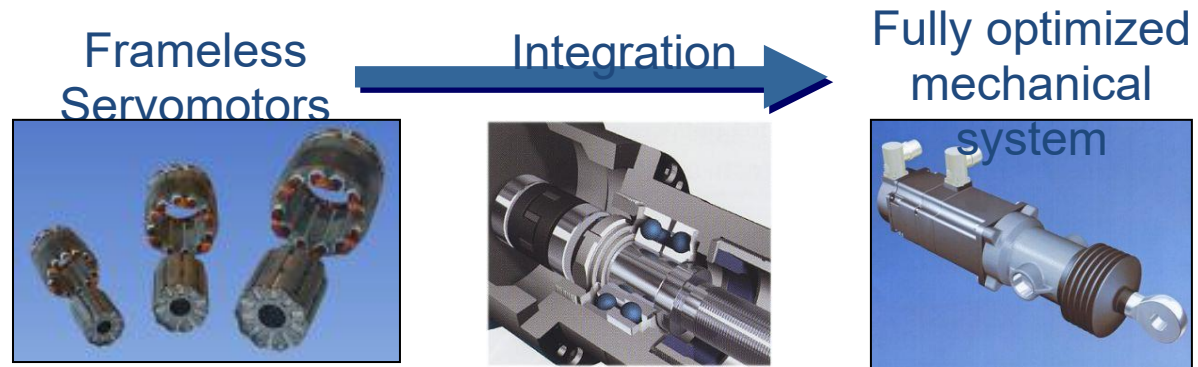

***Partner of your integration :***

- ✓ Flexible organization and technical know-how
- ✓ Assistance during mechanical integration
- ✓ Assistance during mechanical system tuning



Examples

Electric cylinder

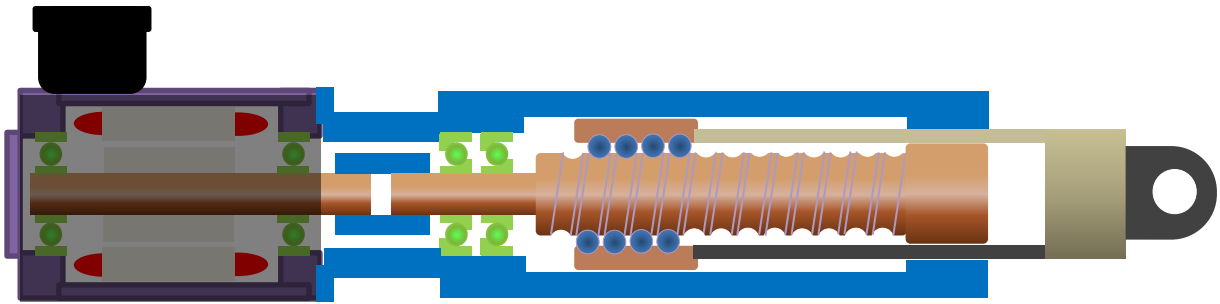

**Mains benefits:**

- ✓ **Cost** (coupling, bearings, motor front flange are deleted and cylinder frame is simple)
- ✓ **Compact** (40% smaller than standard cylinder)
- ✓ **Excellent control** due to the high mechanical stiffness (no coupling)
- ✓ **Lower weight** (ideal for robot application)

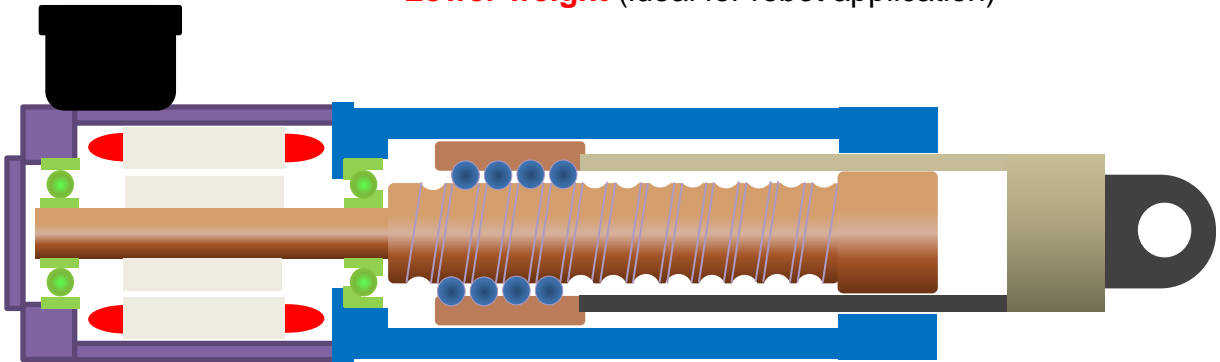

Pump

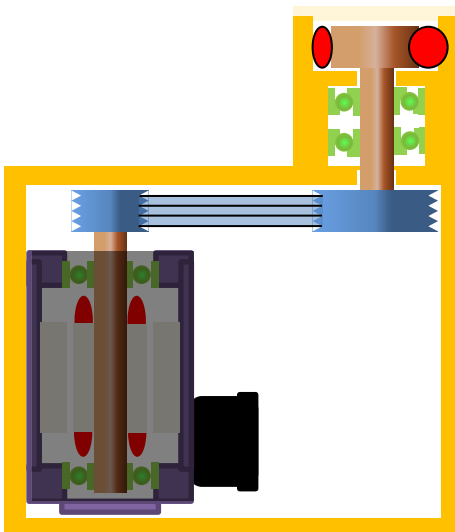

**Mains benefits:**

- ✓ **Low cost**
- ✓ **Compact**
- ✓ **Simplified design**
- ✓ **Low temperature rise**

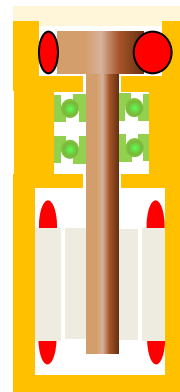
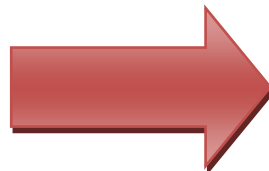

## 2.4. Motor description

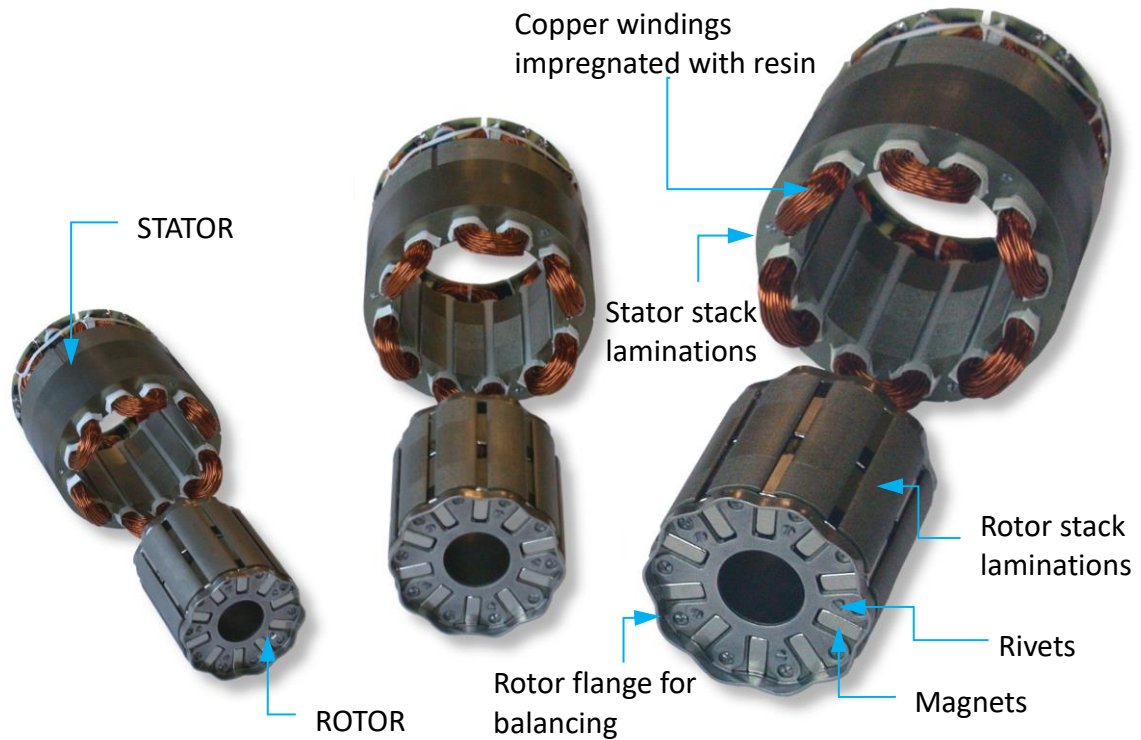

## 2.5. General Technical Data

	<b>NK3, NK4, NK6</b>	<b>NK8</b>
<b>Motor type</b>	Permanent-magnet synchronous motor	
<b>Magnets material</b>	Neodymium Iron Boron	
<b>Number of poles</b>	10	
<b>Degree of protection</b>	IP00	
<b>Cooling</b>	<ul style="list-style-type: none"> <li>• Natural cooling</li> <li>• Water cooled</li> </ul>	
<b>Rated voltage</b>	230VAC, 400 VAC and 480 VAC	
<b>Insulation of the stator winding</b>	Class F according to IEC 60034-1	Class F according to IEC 60034-1 with potting
<b>Altitude</b>	Up to 1000m (IEC 60034-1) (for higher altitude see §3.1.1 for derating)	
<b>Ambient temperature</b>	<ul style="list-style-type: none"> <li>• -15°C to +40°C (IEC 60034-1)</li> <li>• -40°C on request</li> <li>• 0°C to 40°C for water cooled version (IEC 60034-1) to avoid condensation see §3.5</li> </ul>	
<b>Storage temperature</b>	-20... +60°C	
<b>Connection</b>	Cable	



## 2.6. Product Code

Code	N	K	3	1	0	E	A	K	R	1	0	0	0	
<b>Product Series</b>														
<b>Motor size</b> 3, 4, 6 or 8 in relation with the motor diameter														
<b>Motor length</b> up to 60 depend on size														
<b>Windings variant</b> E: standard serial windings class F W: serial windings class F water cooled														
<b>Feedback Sensor</b> A: resolver 2 poles transformation ratio = 0.5 P: Hiperface DSL SIL2 encoder singleturn EKS36 Q: Hiperface DSL SIL2 encoder mutiturn SKM36 R: Hiperface encoder singleturn SKS36 (128pulses) S: Hiperface encoder mutiturn SKM36 (128pulses) Y: sensorless series Z : Special encoder														
<b>Torque / Speed Characteristics</b> See motor data														
<b>Unused character</b>														
<b>Electric connection</b> 1: flying wires														
<b>Mechanical Interface</b> 000: Standard motor Other: custom code														

## 3. TECHNICAL DATA

### 3.1. Motor selection

#### 3.1.1. Altitude derating

**From 0 to 1000 m :** no derating

**1000 to 4000 m:** torque derating of 5% for each step of 1000 m for water cooled

**1000 to 4000 m:** torque derating of 10% for each step of 1000 m for air cooled

#### 3.1.2. Temperature derating

##### 3.1.2.1. Natural cooled motor

The maximal temperature for natural cooling is 40°C. But, it is possible to increase a little bit the ambient temperature above 40°C, with a torque reduction. The following formula gives an indicative about the torque derating at low speed. But in any case refer to PARKER technical department to know the exact values

At low speed the torque derating is given by the following formula for an ambient temperature > 40°C.

$$Torque\_derating[\%] = 100 * \sqrt{\frac{(145^{\circ}C - Ambient\_temperature^{\circ}C)}{105^{\circ}C}}$$

	<p>At high speed, the calculation is more complex, and the derating is much more important. Please refer to PARKER to know the precise data of Torque derating according to ambient temperature at high speed for a specific motor.</p>
--	---

Illustration: Only for example given for the NK620EAR :

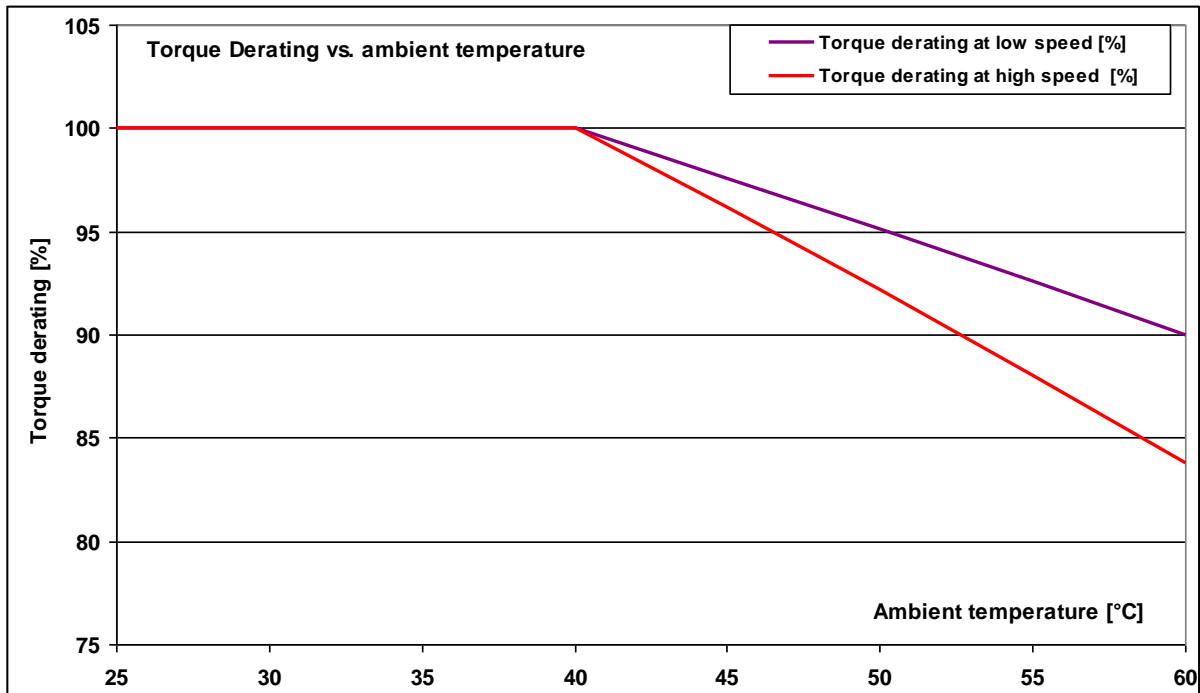

### 3.1.2.2. Water cooled motor

Typical values are given with a water inlet temperature of 25°C and a temperature gradient Inlet-Outlet of 10°C. These references lead to a winding overheating of 95°C corresponding to a winding temperature of 120°C. Recommendations regarding condensation issues are given at § 3.5

It is possible to increase a little bit the Inlet temperature up to 40°C, but the torque must be reduced. The following formula gives an indicative of the torque derating at low speed. But in any case refer to PARKER technical department to know the exact values

At low speed the torque derating is given by the following formula for an water Inlet temperature > 25°C.

$$Torque\_derating[\%] = 100 * \sqrt{\frac{(120^{\circ}C - Inlet\_temperature^{\circ}C)}{95^{\circ}C}}$$

	<p>At high speed, the calculation is more complex, and the derating is much more important. Please refer to PARKER to know the precise data of Torque derating according to water inlet temperature at high speed for a specific motor.</p>
---	---

Illustration: Only for example given for the NK860WAF



### 3.1.3. Thermal equivalent torque (rms torque)

The selection of the right motor can be made through the calculation of the rms torque  $M_{rms}$  (i.e. root mean squared torque) (sometimes called equivalent torque).

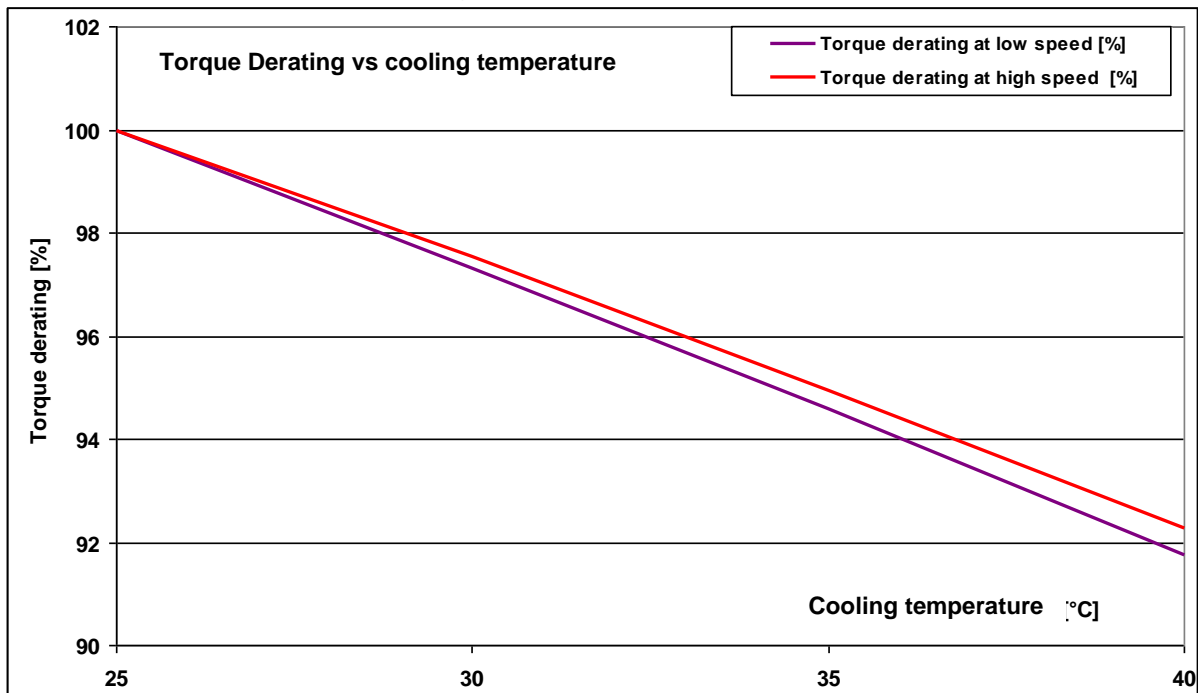
This calculation does not take into account the thermal time constant. It can be used only if the overload time is much shorter than the copper thermal time constant.

The rms torque  $M_{rms}$  reflects the heating of the motor during its duty cycle.

Let us consider:

- the period of the cycle  $T$  [s],
- the successively samples of movements  $i$  characterized each ones by the maximal torque  $M_i$  [Nm] reached during the duration  $\Delta t_i$  [s].

So, the rms torque  $M_{rms}$  can be calculated through the following basic formula:

$$M_{rms} = \sqrt{\frac{1}{T} * \sum_{i=1}^n M_i^2 \Delta t_i}$$

Example:

For a cycle of 2s at 0 Nm and 2s at 10Nm and a period of 4 s, the rms torque is

$$M_{rms} = \sqrt{\frac{1}{4} * 10^2 * 2} = 7,07 Nm$$

Illustration :

Acceleration-deceleration torque:	10 Nm for 0,1 s.
Resistant torque:	1 Nm during all the movement.
Max-min speed:	$\pm 2800$ rpm during 0,2 s.
Max torque provided by the motor:	11 Nm.
rms torque:	6 Nm.

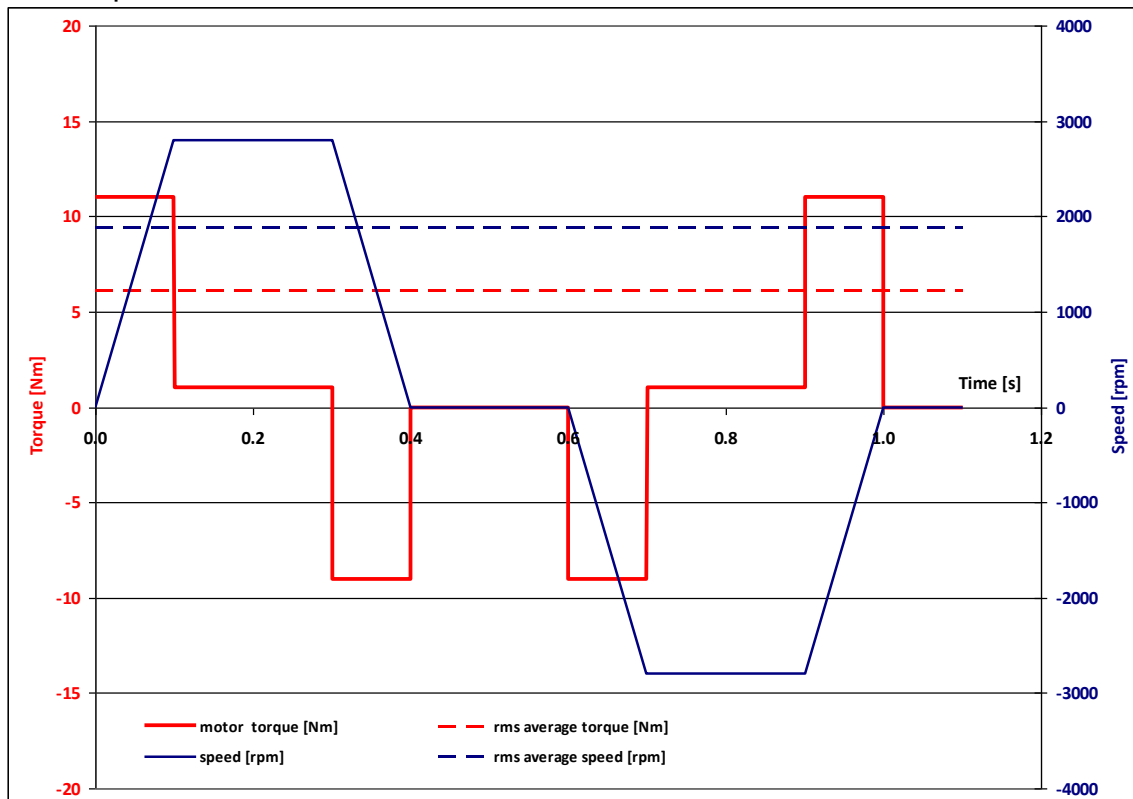

The maximal torque  $M_i$  delivered by the motor at each segment  $i$  of movement is obtained by the algebraic sum of the acceleration-deceleration torque and the resistant torque. Therefore,  $M_{max}$  corresponds to the maximal value of  $M_i$ .

**Selection of the motor :**

The motor adapted to the duty cycle has to provide the rms torque  $M_{rms}$  at the rms speed(\*) without extra heating. This means that the permanent torque  $M_n$  available at the average speed presents a sufficient margin regarding the rms torque  $M_{rms}$ .

$$\Omega_{rms} = \sqrt{\frac{1}{T} * \sum_{i=1}^n \Omega_i^2 \Delta t_i}$$

(\*) rms speed is calculated thanks to the same formula as that used for the rms torque. The mean speed cannot be used (in general mean speed is equal to zero). Only use the rms speed.

Furthermore, each  $M_i$  and speed associated  $\Omega_i$  of the duty cycle has to be located in the operational area of the torque vs speed curve.

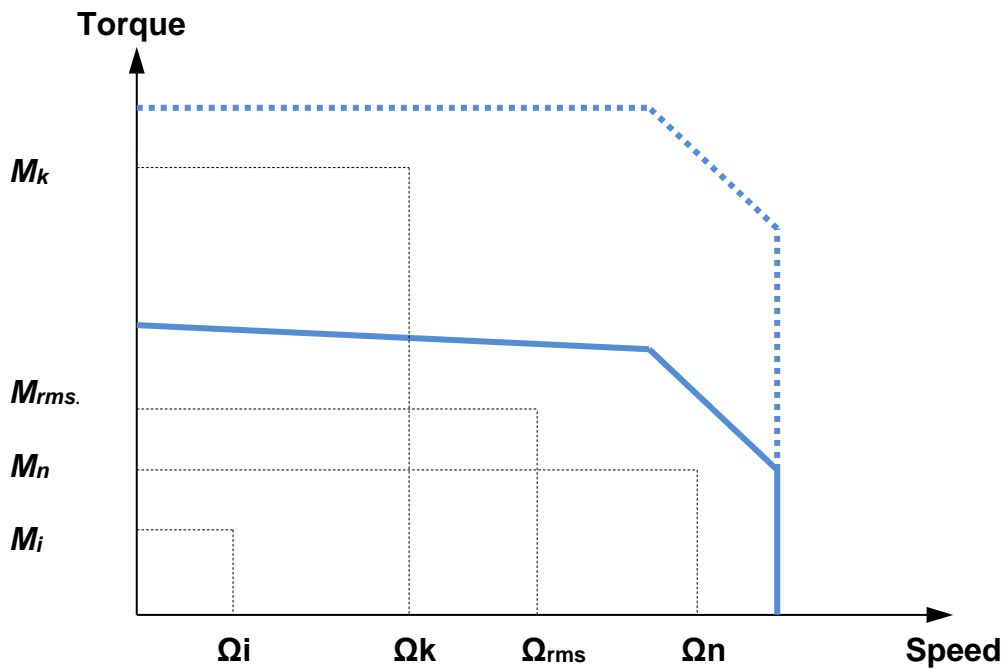

### 3.1.4. Drive selection

Drive selection depends on its rated power and its mode selection which leads to the maximal current duration.

	<p>Please refer to the drive technical documentation for any further information and to select the best motor and drive association.</p>
--	--

#### AC890 PARKER drive example:

The rated current provided by the AC890 drive depends on its rated power and its mode selection. “Vector mode” is used for induction motors while “Servo mode” is used for brushless AC motors. With NK motors the power is usually < 37 kW, the rated current corresponds to 100 %.

Power of Drive AC890 [kW]	< 37 kW	
Mode	Vector mode	Servo mode
Overload capability [%]	150 % during 60 s	200 % during 4 s

#### Illustration:

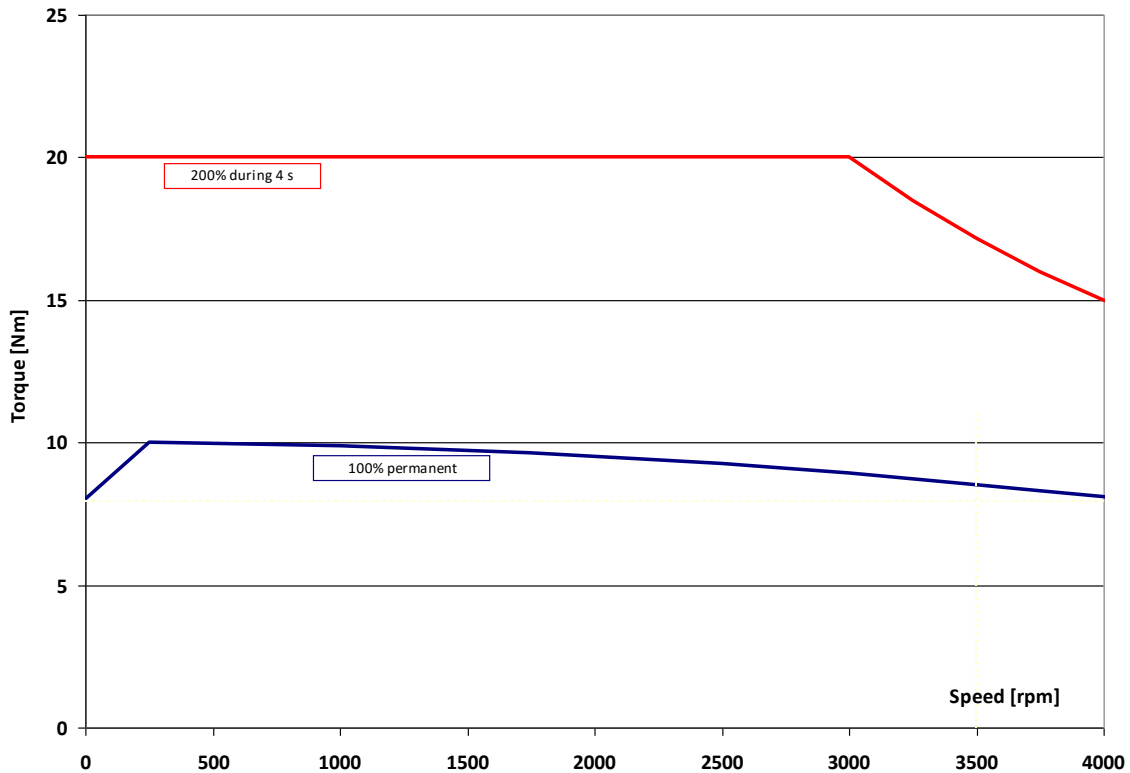





**Example n°1 :**

The application needs:

- a rms torque of **7 Nm** at the rms speed of **2000 rpm**,
- an acceleration torque of **12 Nm**,
- a maximal speed of **2800 rpm**.

**Selection of the motor:**

The selected motor is the type **NK620EAR**.

The nominal speed is equals to 3900 rpm.

The maximal speed is equals to 3900 rpm.

The torque sensitivity is equals to 1.47 Nm/Arms.

BRUSHLESS MOTORS			
<b>NK620EAR</b>			
ELECTRONIC DRIVE			
<b>DIGIVEX 8/16</b> (400V)			

No UL certification

Torque at low speed	$M_0$	Nm	8	
Permanent current at low speed	$I_0$	$A_{rms}$	5.31	
Peak torque	$M_p$	Nm	26.7	--
Current for the peak torque	$I_p$	$A_{rms}$	21.2	--
Back emf constant at 1000 rpm (25°C)*	$K_e$	$V_{rms}$	95.7	
Torque sensitivity	$K_t$	$Nm/A_{rms}$	1.51	
Winding resistance (25°C)*	$R_b$	$\Omega$	2.24	
Winding inductance*	$L$	mH	19.2	
Rotor inertia	$J$	$kgm^2 \times 10^{-5}$	98	
Thermal time constant	$T_{th}$	min	27	
Motor mass	$M$	kg	7	
Voltage of the mains	UR1 UR2 UR3	$V_{rms}$	400	- -
Rated speed	Nn1 Nn2 Nn3	rpm	3900	- -
Rated torque	Mn1 Mn2 Mn3	Nm	6.17	- -
Rated current	In1 In2 In3	$A_{rms}$	4.25	- -
Rated power	Pn1 Pn2 Pn3	W	2520	- -

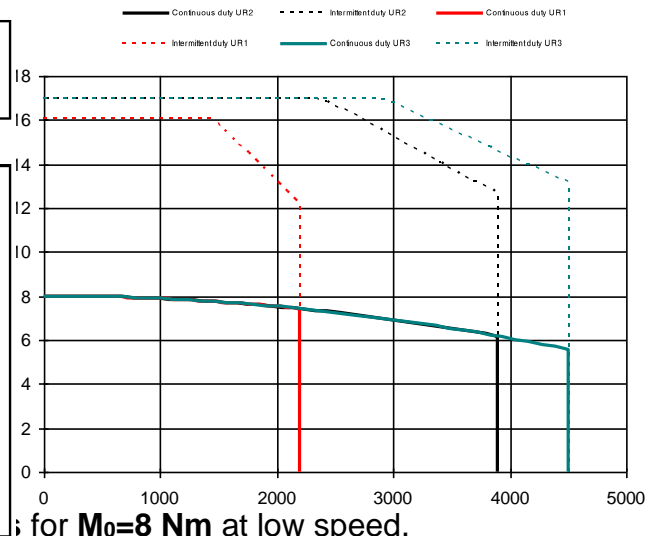

for  $M_0=8$  Nm at low speed.

The nominal current  $I_n$  of the motor is **4.25 Arms** for  $M_n=6.17$  Nm at the nominal speed.

**Selection of the drive:**

The drive has to provide at least a permanent current equals to  $I_0$  (5.31 Arms).

In order to obtain an acceleration torque of **12 Nm**, the current will be about 8 Arms (the motor data sheet shows 17 Nm with 11.3 Arms). This means that the drive has to provide at least 8 Arms as transient current.

→ Therefore, we can select the drive **AC890SD-53 2100 B** which delivers under 400 VAC:

**6 Arms** as permanent current and **6\*200%=12 Arms** as maximal transient current during 4 s.

The drive is set with **“Servo Mode”**.

→ We also can select the drive **DIGIVEX 8/16 A** which delivers under 400 VAC:

**5.6 Arms** as permanent current and **5.6\*200%=11.3 Arms** as maximal transient current during 2 s.



### Example n°2 :

This times; the application needs :

- a permanent torque of **5.8 Nm** at low speed,
- a rms torque of **5.8 Nm** at the rms speed of **1890 rpm**,
- an acceleration torque of **8.8 Nm**,
- a maximal speed of **2800 rpm**.

### Selection of the motor:

The selected motor is the type **NK620EAR**.

The nominal speed is equals to 3900 rpm.

The maximal speed is equals to 3900 rpm.

The torque sensitivity is equals to 1.47 Nm/Arms.

### Selection of the drive:

The drive has to provide a permanent current equals to 4 Arms to obtain 5.8 Nm.

In order to obtain an acceleration torque of **8.8 Nm**, the current will be of about 6 Arms

This means that the drive has to provide at less 6 Arms as transient current.

Compared to the previous example n°1, it is now possible to decrease the size of drive.

→ Therefore, we can select the drive **AC890SD-53 1600 B** which delivers under 400 VAC:

**4 Arms** as permanent current and

**4\*200%=8 Arms** as maximal transient current during 4 s.

The drive is set with “**Servo Mode**”.

### 3.1.5. Current limitation at stall conditions (i.e. speed < 3 rpm)

Recommended reduced current at speed < 3 rpm:

$$I_{reduced} = \frac{1}{\sqrt{2}} * I_0 \cong 0.7 * I_0$$

	<p><b>Warning:</b> The current must be limited to the prescribed values. If the nominal torque has to be maintained at stop or low speed (&lt; 3 rpm), imperatively limit the current to 70% of I<sub>0</sub> (permanent current at low speed), in order to avoid an excessive overheating of the motor.</p>
	<p>Please refer to the drive technical documentation for any further information and to choose functions to program the drive.</p>

### 3.1.6. Peak current limitations

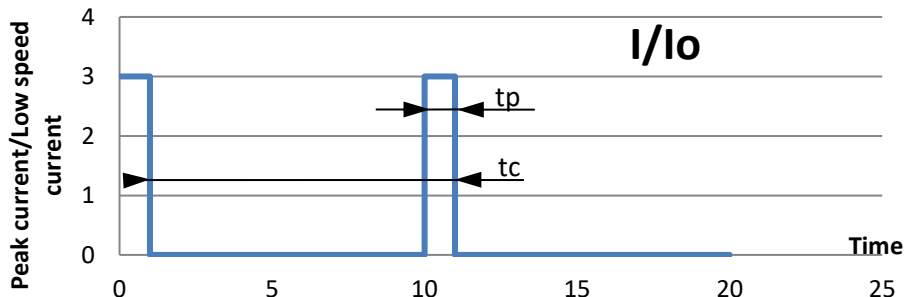

It is possible to use the NK motor with a current higher than the permanent current. But, to avoid any overheating, the following rules must be respected.

- 1) The peak currents and peak torques given in the data sheet must never be exceeded
- 2) The thermal equivalent torque must be respected (§3.1.3)
- 3) If 1) and 2) are respected (it can limit the peak current value or duration), the peak current duration (tp) must be limited, in addition, accordingly to the following table (I<sub>0</sub> is the permanent current at low speed):

I <sub>peak</sub> /I <sub>n</sub>	I <sub>p</sub> /I <sub>0</sub> = 2	I <sub>p</sub> /I <sub>0</sub> = 3	I <sub>p</sub> /I <sub>0</sub> = 4	I <sub>p</sub> /I <sub>0</sub> > 5
NK310	tp < 0.8 s	tp < 0.3s	tp < 0.15s	tp < 0.1s
NK420				
NK430				
NK620	tp < 1.5s	tp < 0.6s	tp < 0.3s	tp < 0.2s
NK630				
NK820				
NK840				
NK860	tp < 3s	tp < 1.5s	not allowed	
NK860V				
NK860W				

The peak current duration is calculated for a temperature rise of 3°C  
Consult us for more demanding applications.

### 3.2. NK Characteristics: Torque, speed, current, power...

The torque vs speed graph below explains different intrinsic values of the next tables.

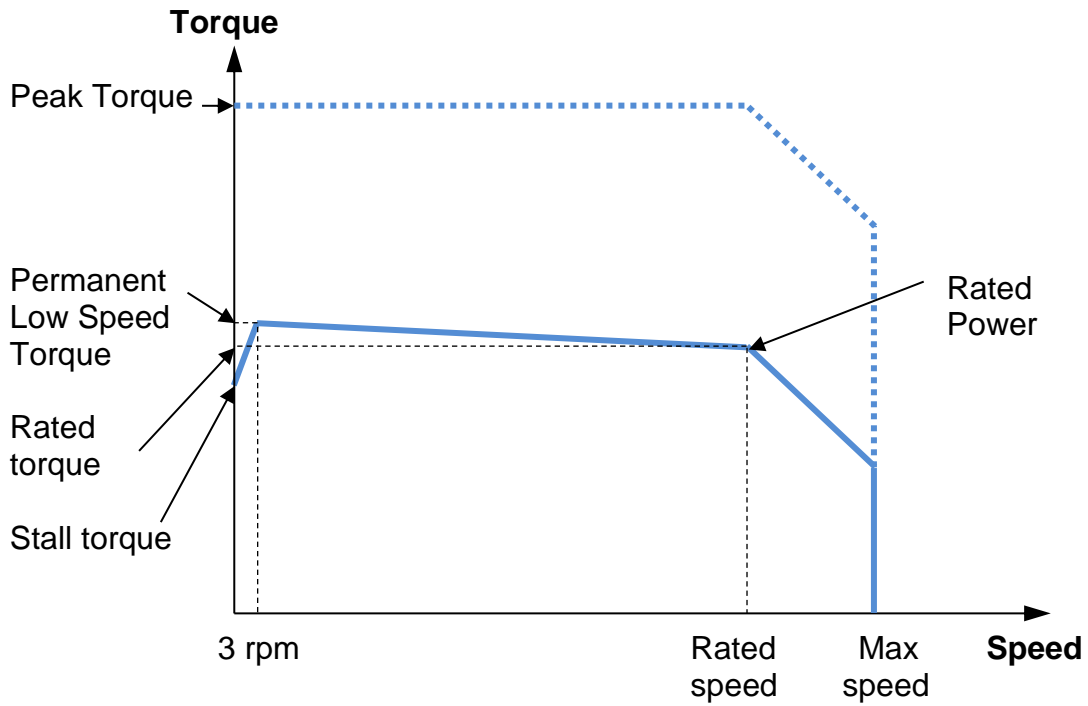

### 3.2.1. NK data with natural cooling – Mains voltage 230V

Motor	Rated Power Pn (kW)	Rated Torque Mn (Nm)	Rated Current In [Arms]	Low speed torque Mo [Nm]	Low speed Current Io [Arms]	Peak Torque Mpeak [Nm]	Peak Current I peak [Arms]	Max. Speed Nmax [rpm]
NK310E_P	0,43	1,8	1,27	2	1,4	6,6	5,6	2300
NK310E_K	0,69	1,65	2,06	2	2,4	6,6	9,7	4000
NK420E_P	0,85	3,53	2,41	4	2,7	13,4	10,9	2300
NK420E_J	1,31	3,14	3,74	4	4,7	13,4	18,9	4000
NK430E_J	1,57	4,68	4,53	5,5	5,2	18,7	21,0	3200
NK430E_F	1,80	4,29	5,28	5,5	6,6	18,7	26,6	4000
NK620E_R	1,71	7,42	4,99	8	5,3	26,6	21,2	2200
NK620E_J	2,55	6,08	7,82	8	9,9	26,6	39,5	4000
NK630E_R	1,63	10,7	4,75	12	5,3	39,9	21,0	1450
NK630E_K	2,70	9,21	7,8	12	9,9	39,9	39,4	2800
NK630E_G	3,48	8,31	10,1	12	13,9	39,9	55,7	4000
NK820E_L	4,99	13,2	14,8	16	17,6	49,9	69,2	3600
NK840E_J	5,27	22,9	15,7	28	18,9	91,8	74,8	2200
NK860E_F	6,53	32,8	21,8	41	27,0	136,0	107,6	1900
NK860E_D	7,48	27,5	22,5	41	33,0	136,0	131,6	2600

### 3.2.2. NK data with natural cooling – Mains voltage 400V

Motor	Rated Power Pn (kW)	Rated Torque Mn (Nm)	Rated Current In [Arms]	Low speed torque Mo [Nm]	Low speed Current Io [Arms]	Peak Torque Mpeak [Nm]	Peak Current I peak [Arms]	Max. Speed Nmax [rpm]
NK310E_P	0,689	1,65	1,2	2	1,4	6,6	5,6	4000
NK420E_V	0,753	3,6	1,2	4	1,4	13,4	5,5	2000
NK420E_P	1,31	3,14	2,2	4	2,7	13,4	10,9	4000
NK430E_V	0,563	5,38	1,4	5,5	1,4	18,7	5,6	1000
NK430E_P	1,5	4,77	2,5	5,5	2,8	18,7	11,3	3000
NK430E_L	1,8	4,29	3,0	5,5	3,8	18,7	15,1	4000
NK620E_V	1,57	7,52	2,7	8	2,8	26,6	11,3	2000
NK620E_R	2,52	6,17	4,3	8	5,3	26,6	21,2	3900
NK620E_J	2,45	4,1	5,6	8	9,9	26,6	39,5	5700
NK630E_V	1,53	10,8	2,4	12	2,6	39,9	10,5	1350
NK630E_R	2,64	9,34	4,2	12	5,3	39,9	21,0	2700
NK630E_N	3,18	7,6	5,3	12	7,9	39,9	31,7	4000
NK820E_X	2,93	14,7	4,8	16	5,2	49,9	20,3	1900
NK820E_R	5,29	12,9	9,1	16	11,0	49,9	43,2	3900
NK840E_Q	5,09	23,2	8,5	28	10,1	91,8	39,9	2100
NK840E_K	6,8	18,6	11,5	28	16,8	91,8	66,5	3500
NK860E_J	7,48	27,5	12,7	41	18,5	136,0	74,0	2600

### 3.2.3. NK data with water cooling – Mains voltage 400V

Motor	Rated Power Pn (kW)	Rated Torque Mn (Nm)	Rated Current In [Arms]	Low speed torque Mo [Nm]	Low speed Current Io [Arms]	Peak Torque Mpeak [Nm]	Peak Current I peak [Arms]	Max. Speed Nmax [rpm]
NK310W_F	3,8	2,5	7,4	3,1	8,9	5,89	18,0	15000
NK420W_D	4,9	4,64	12,6	6,1	16,3	12,6	36,4	12000
NK430W_D	7,4	7,26	14,1	9,6	18,3	18,9	38,9	10000
NK620W_C	7,7	10,7	20,7	15	29	23,5	48,0	10000
NK630W_D	11,8	17,8	31,2	23	40,1	38,7	72,8	8000
NK820W_G	12,6	19	35,2	24	44,1	37,9	75,0	8000
NK840W_D	26,4	42,7	52,7	53	65,3	75,8	100,0	6500
NK860W_D	34,8	83,2	64,6	90	70,2	140	123,2	4000

### 3.2.4. Further Data with **natural cooling**

Motor	Ke [Vrms/krpm]	Kt (sine) [Nm/Arms]	Winding Resistance [ohms]	Inductance [mH]	Moment of Inertia J [kgmm <sup>2</sup> ]	Motor Weight [kg]
NK310E_K	50,9	0,823	6,58	20,3	79	1,0
NK310E_P	88,9	1,440	20,70	62,0	79	1,0
NK420E_J	51,9	0,853	2,31	11,0	290	2,0
NK420E_P	89,9	1,480	7,20	33,0	290	2,0
NK420E_V	179,0	2,940	28,40	131,0	290	2,0
NK430E_F	51,8	0,828	1,38	6,8	426	2,8
NK430E_J	65,6	1,050	2,19	10,9	426	2,8
NK430E_L	90,9	1,450	4,22	21,0	426	2,8
NK430E_P	122,0	1,950	7,26	37,8	426	2,8
NK430E_V	244,0	3,900	29,00	151,0	426	2,8
NK620E_J	51,3	0,809	0,60	5,5	980	4,3
NK620E_R	95,7	1,510	2,24	19,2	980	4,3
NK620E_V	180,0	2,830	7,90	67,6	980	4,3
NK630E_G	52,1	0,861	0,34	3,5	1 470	6,0
NK630E_K	73,6	1,220	0,67	7,1	1 470	6,0
NK630E_N	91,6	1,510	1,12	10,9	1 470	6,0
NK630E_R	138,0	2,290	2,43	24,9	1 470	6,0
NK630E_V	277,0	4,570	9,19	99,6	1 470	6,0
NK820E_L	56,9	0,911	0,38	3,4	3 200	6,5
NK820E_R	91,0	1,460	1,01	8,6	3 200	6,5
NK820E_X	193,0	3,100	4,53	38,7	3 200	6,5
NK840E_J	92,8	1,480	0,37	4,3	6 200	12,0
NK840E_K	104,0	1,670	0,49	5,4	6 200	12,0
NK840E_Q	174,0	2,780	1,36	15,1	6 200	12,0
NK860E_D	78,7	1,240	0,16	2,0	9 200	17,0
NK860E_F	96,1	1,520	0,24	3,0	9 200	17,0
NK860E_J	140,0	2,210	0,50	6,4	9 200	17,0

### 3.2.5. Further Data with water cooling

Motor	Ke [Vrms/krpm]	Kt (sine) [Nm/Arms]	Winding Resistance [ohms]	Inductance [mH]	Moment of Inertia J [kgmm <sup>2</sup> ]	Water Flow [l/min]
NK310W_F	22,2	0,349	1,08	2,90	79	0,9
NK420W_D	24,0	0,375	0,49	2,14	290	1,3
NK430W_D	33,5	0,523	0,58	2,50	420	1,6
NK620W_C	33,0	0,517	0,24	1,91	980	1,6
NK630W_D	36,6	0,574	0,17	1,57	1 470	2,1
NK820W_G	34,8	0,544	0,14	1,22	3 200	1,6
NK840W_D	52,1	0,811	0,12	1,40	6 200	3,3
NK860W_D	82,8	1,280	0,16	2,04	9 200	5,0



### 3.2.6. Efficiency curves



Caution: The efficiency curves are typical values. They may vary from one motor to another



Caution: The efficiency curves are given for an optimal motor control (no voltage saturation and optimal phase between current and EMF)



Caution: The efficiency curves do not include the losses due to the switching frequency.



### 3.2.6.1. Series NK310E

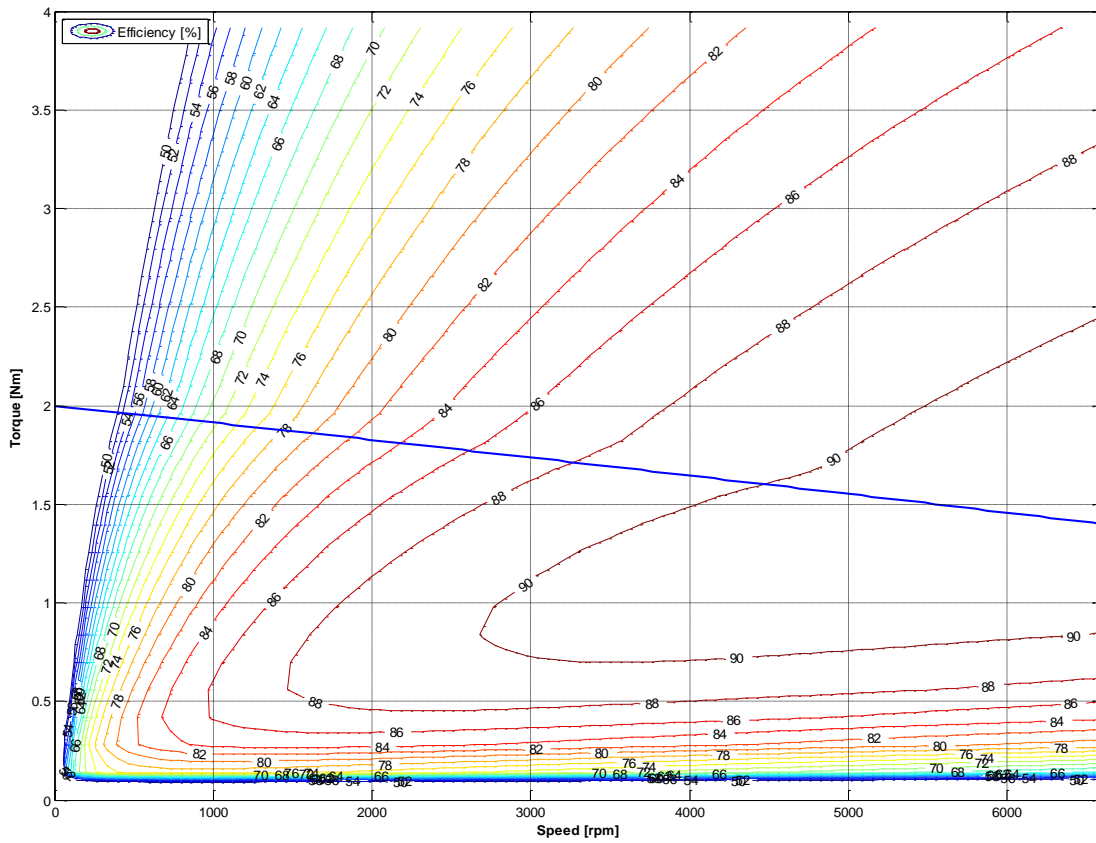



### 3.2.6.2. Series NK420E

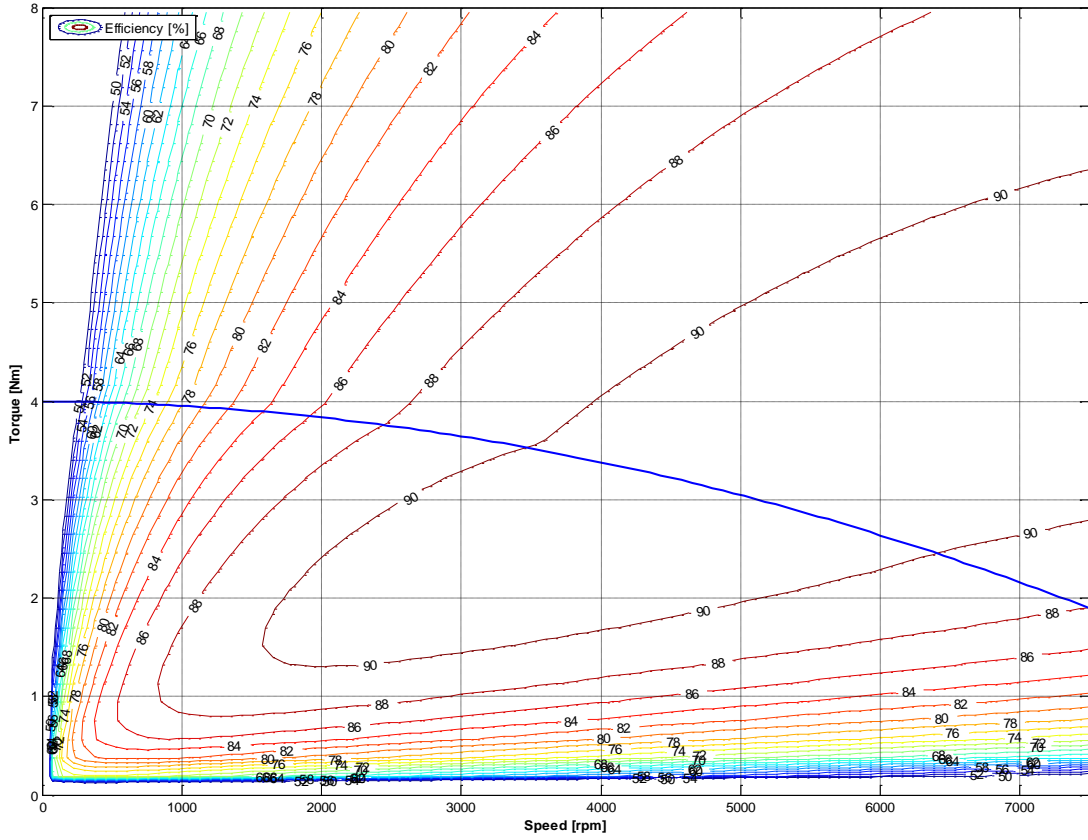

### 3.2.6.3. Series NK430E

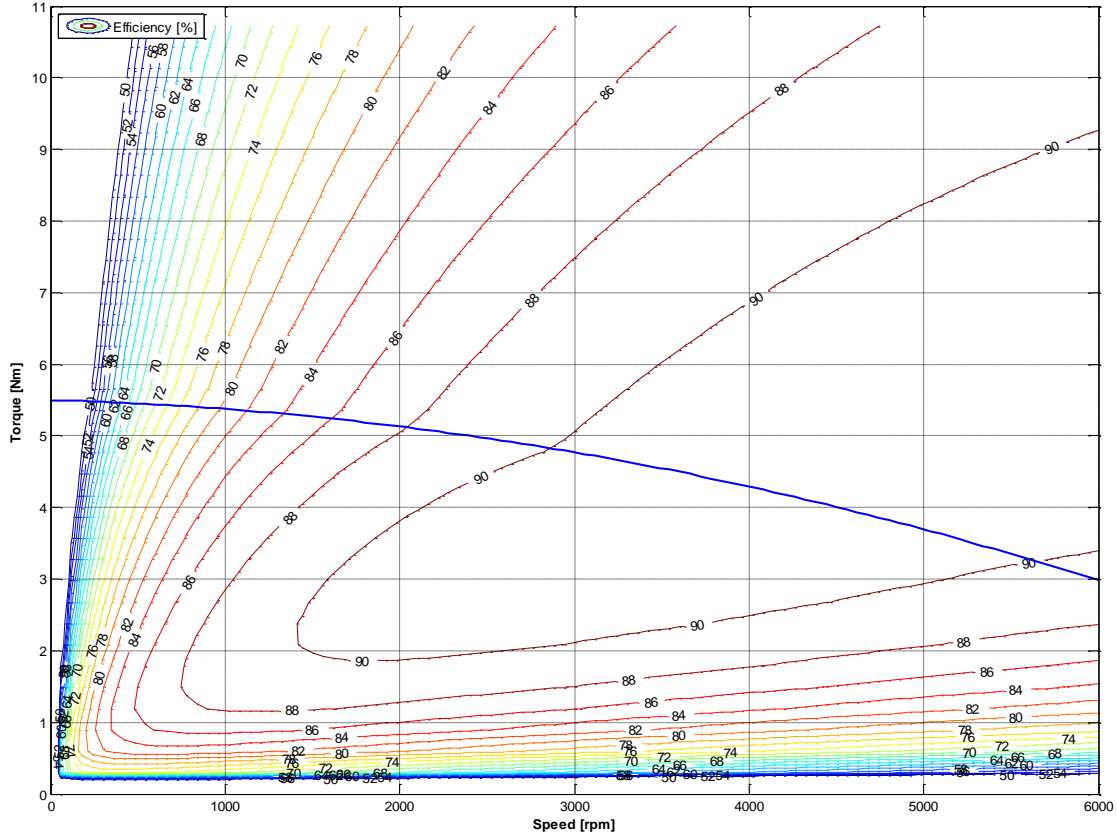



### 3.2.6.4. Series NK620E

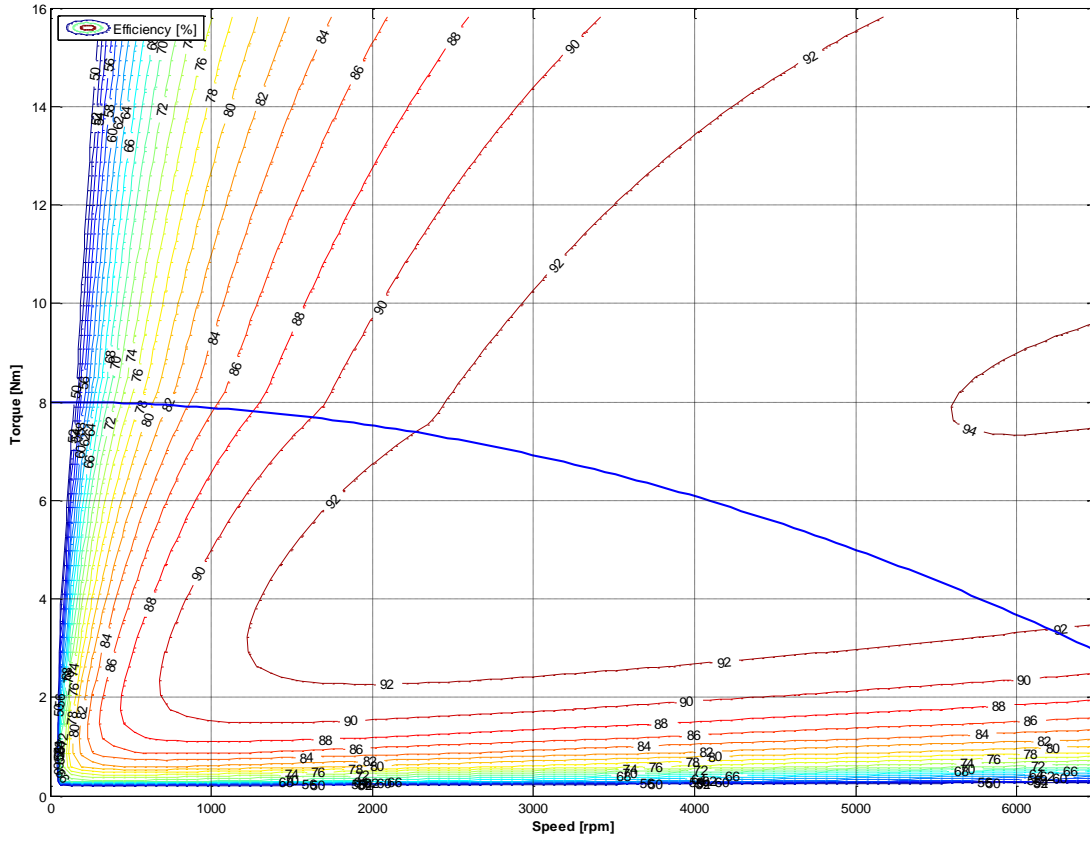

### 3.2.6.5. Series NK630E

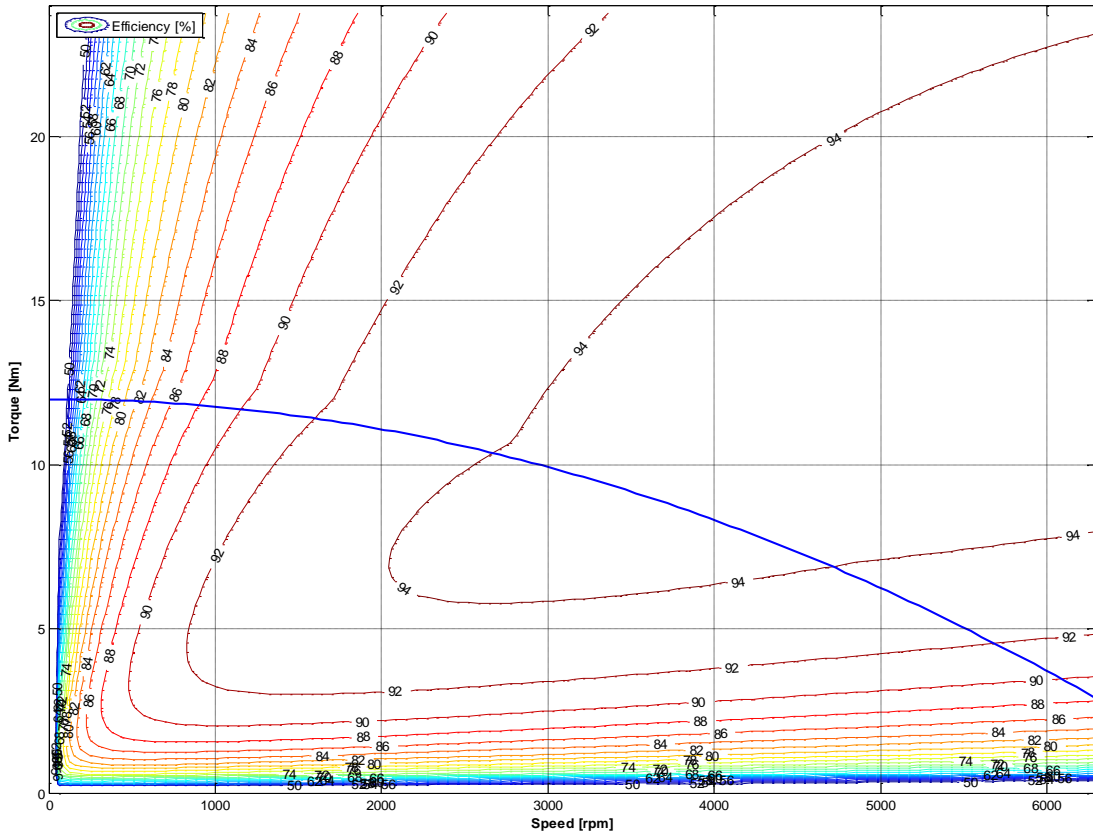



### 3.2.6.6. Series NK820E

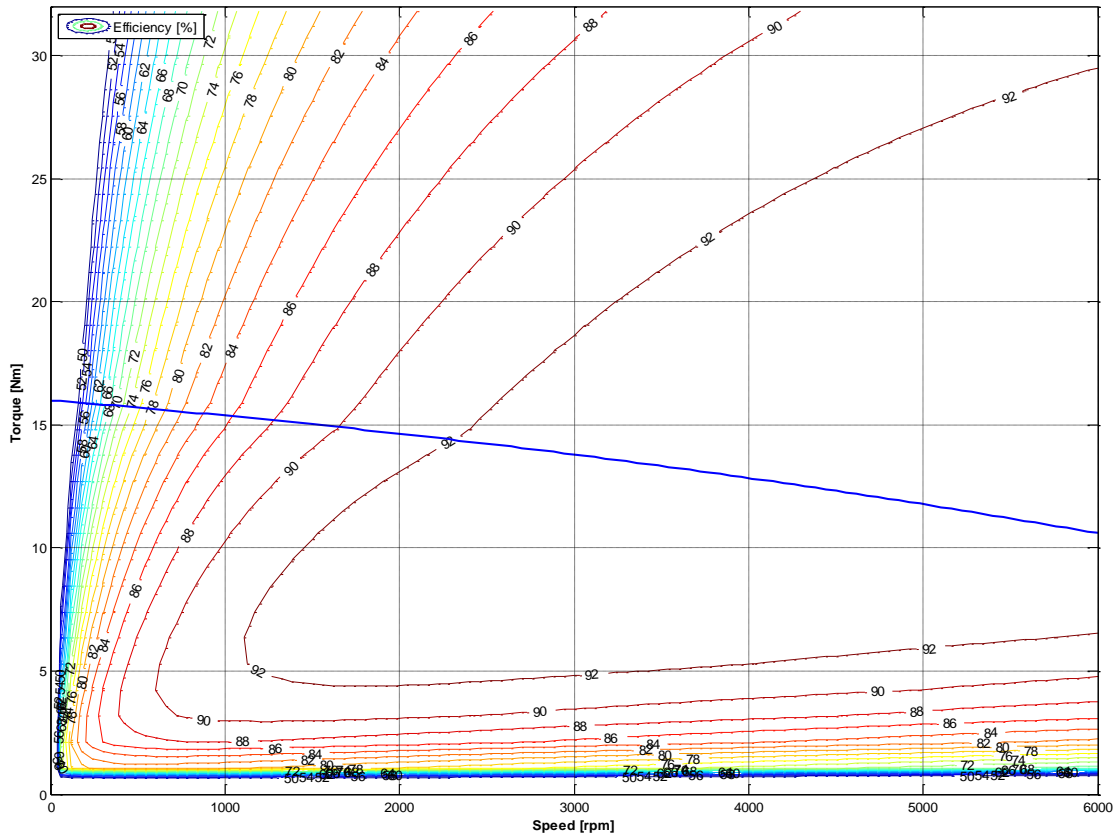

### 3.2.6.7. Series NK840E

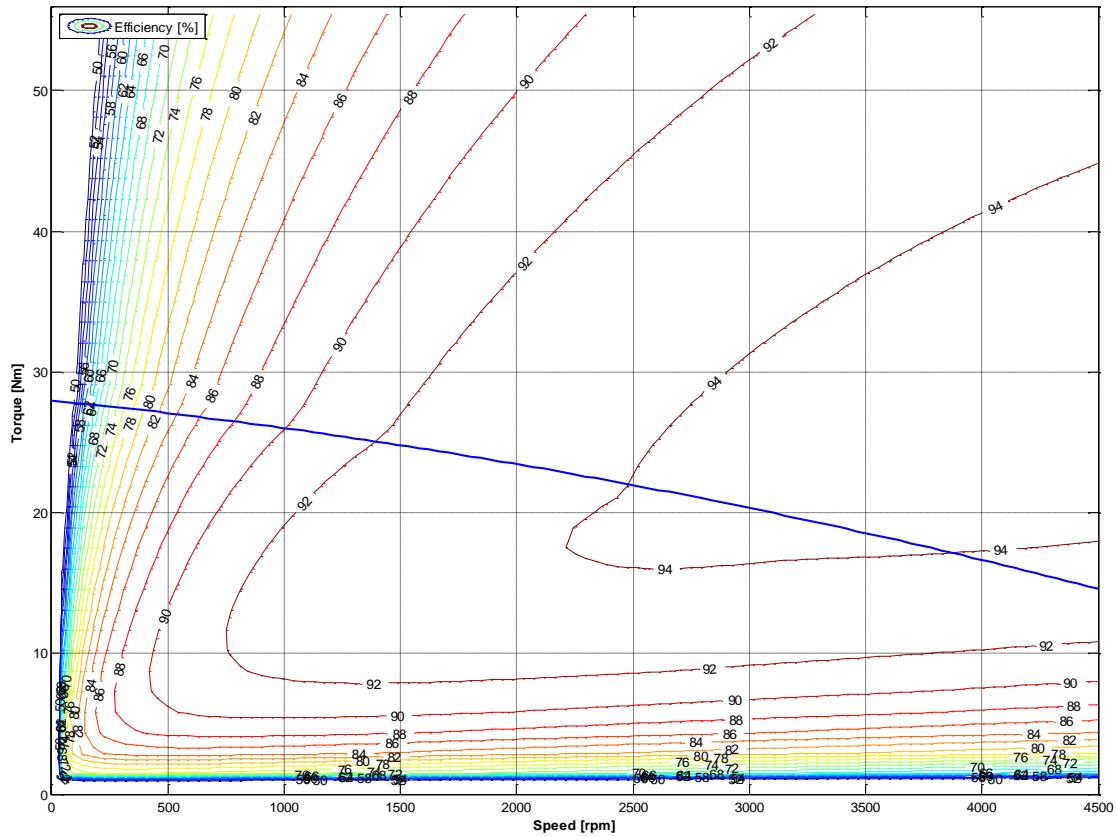



### 3.2.6.8. Series NK860E

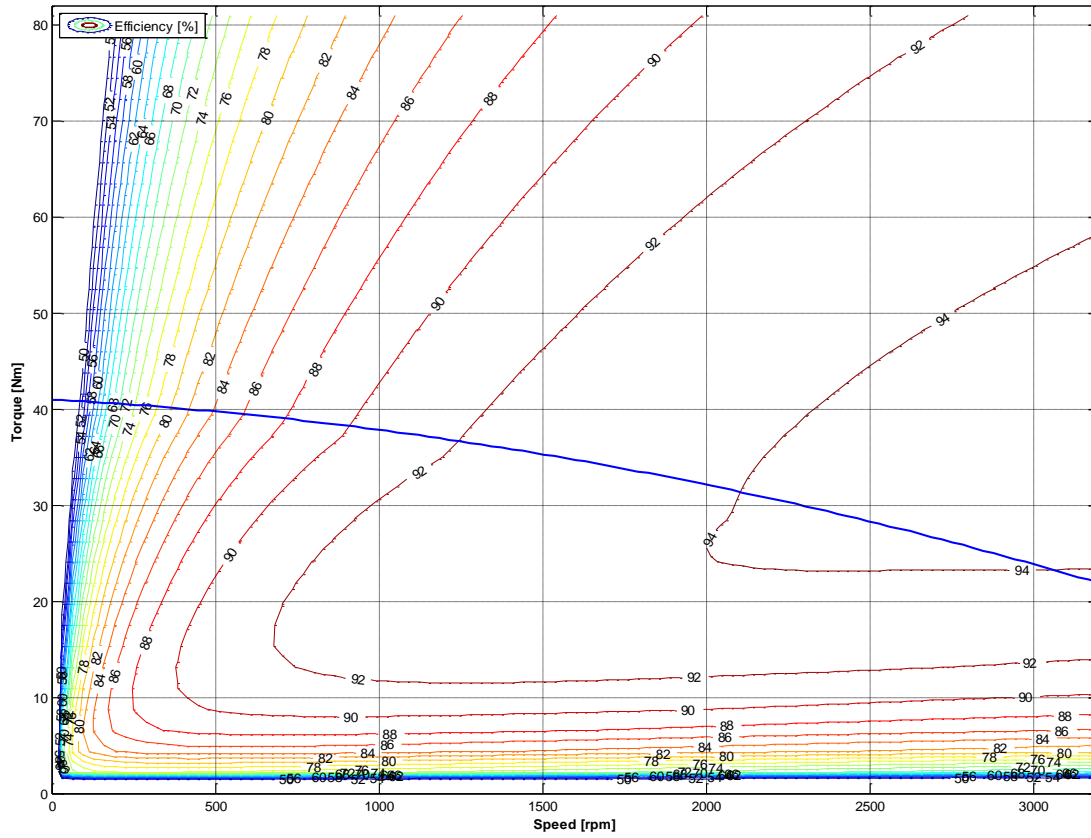



### 3.2.6.9. Series NK860V

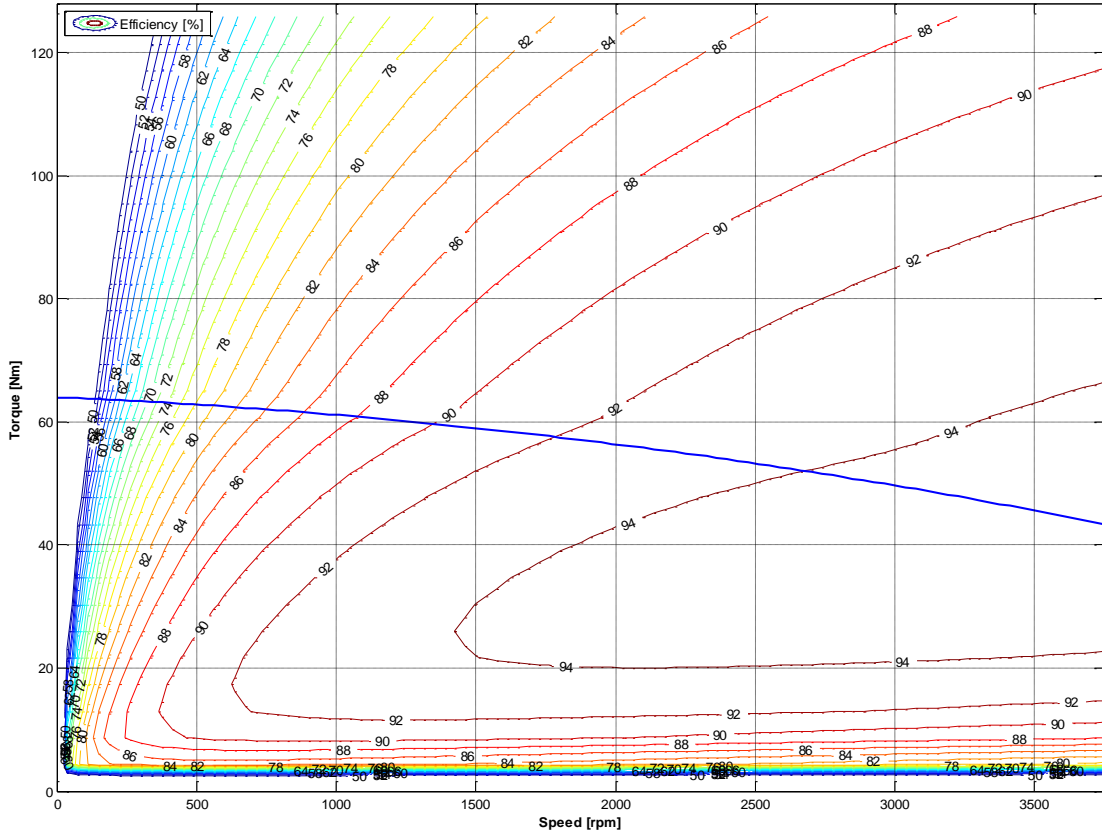

### 3.2.6.10. Series NK860W

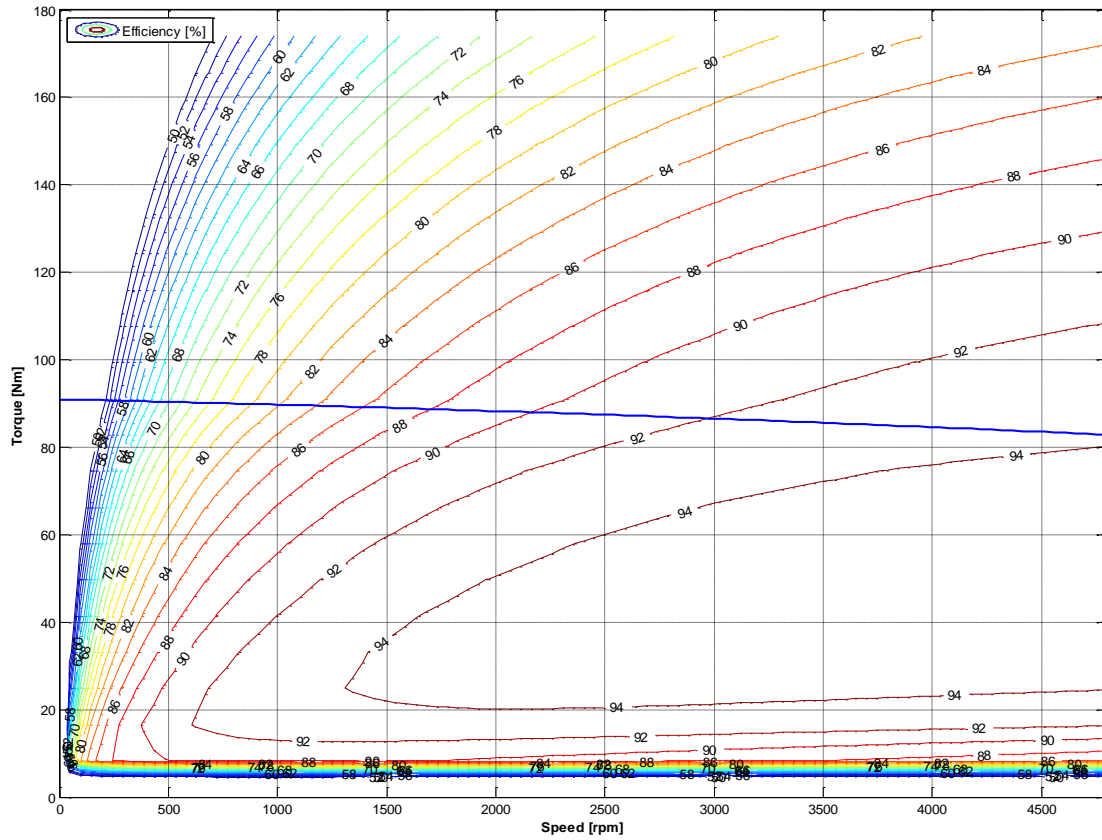

### 3.2.7. Electromagnetic losses



Caution: Following data result from our best estimations but are indicative. They can vary from one motor to another and with temperature. No responsibility will be accepted for direct or indirect losses or damages due to the use of these data.

Tf: Rotor shaft Dynamic Friction  
Kd: Rotor shaft Viscous Damping  
Torque losses = Tf + Kd x speed/1000

(Following data are indicative at the rated power)

Type	Tf [Nm]	Kd [Nm/1000rpm]
NK310	0.067	0.033
NK420	0.090	0.114
NK430	0.106	0.149
NK620	0.106	0.196
NK630	0.131	0.245
NK820	0.160	0.300
NK840	0.190	0.380
NK860	0.220	0.460



### 3.2.8. Time constants of the motor

#### 3.2.8.1. Electric time constant:

$$\tau_{elec} = \frac{L_{ph\_ph}}{R_{ph\_ph}}$$

With following values given in the motor data sheet  
 $L_{ph\_ph}$  inductance of the motor phase to phase [H],  
 $R_{ph\_ph}$  resistance of the motor phase to phase at 25°C [Ohm].

#### Example:

Motor series NK620EAR

$L_{ph\_ph} = 19.2$  mH or  $19.2 \cdot 10^{-3}$  H

$R_{ph\_ph}$  at 25°C = 2.24 Ohm

→  $\sigma_{elec} = 19.2 \cdot 10^{-3} / 2.24 = 8.6$  ms

An overall summary of motor time constants is given a little further.

#### 3.2.8.2. Mechanical time constant:

$$\tau_{mech} = \frac{R_{ph\_n} * J}{Kt * Ke_{ph\_n}} = \frac{0.5 * R_{ph\_ph} * J}{(3 * \frac{Ke_{ph\_ph}}{\sqrt{3}}) * \frac{Ke_{ph\_ph}}{\sqrt{3}}}$$

$$\tau_{mech} = \frac{0.5 * R_{ph\_ph} * J}{(Ke_{ph\_ph})^2}$$

With following values obtained from the motor data sheet:

$R_{ph\_ph}$  resistance of the motor phase to phase at 25°C [Ohm],

$J$  inertia of the rotor [kgm<sup>2</sup>],

$Ke_{ph\_ph}$  back emf coefficient phase to phase [V<sub>rms</sub>/rad/s].

The coefficient  $Ke_{ph\_ph}$  in the formula above is given in [V<sub>rms</sub>/rad/s]

To calculate this coefficient from the datasheet, use the following relation:

$$Ke_{ph\_ph} [V_{rms} / rad / s] = \frac{Ke_{ph\_ph} [V_{rms} / 1000rpm]}{2 * \pi * 1000 / 60}$$

#### Example:

Motor series NK620EAR

$R_{ph\_ph}$  at 25°C = 2.24 Ohm

$J = 98 \cdot 10^{-5}$  kgm<sup>2</sup>

$Ke_{ph\_ph} [V_{rms} / 1000rpm] = 95.7$  [V<sub>rms</sub>/1000rpm]

→  $Ke_{ph\_ph} [V_{rms} / rad / s] = 95.7 / (2 * \pi * 1000 / 60) = 0.9139$  [V<sub>rms</sub>/rad/s]

→  $\sigma_{mech} = 0.5 * 2.24 * 98 \cdot 10^{-5} / (0.9139^2) = 1.2$  ms



**Remarks:**

For a DC motor, the mechanical time constant  $\sigma_{mech}$  represents the duration needed to reach 63% of the final speed when applying a voltage step without any resistant torque. However this value makes sense only if the electric time constant  $\sigma_{elec}$  is much smaller than the mechanical time constant  $\sigma_{mech}$  (for the motor NK620EAR taken as illustration, it is not the case because we obtain  $\sigma_{mech} < \sigma_{elec}$ ).

An overall summary of motor time constants is given a little further.

**3.2.8.3. Thermal time constant of the copper:**

$$\tau_{therm} = Rth_{copper\_iron} * Cth_{copper}$$

$$Cth_{copper [J/^{\circ}K]} = Mass_{copper [Kg]} * 389_{[J/kg^{\circ}K]}$$

With:

**Rth<sub>copper\_iron</sub>** thermal resistance between copper and iron [°K/W]

**Cth<sub>copper</sub>** thermal capacity of the copper [J/°K]

**Mass<sub>copper</sub>** mass of the copper (winding) [kg]

Hereunder is given an overall summary of motor time constants:

Type	Electric time constant [ms]	Mechanical time constant [ms]	Thermal time constant of copper [s]
NK310E	3.0	1.1	60.2
NK310W	2.7	0.9	26.7
NK420E	4.6	1.4	71.0
NK420W	4.4	1.3	29.8
NK430E	5.2	1.1	79.8
NK430W	4.3	1.2	24.7
NK620E	8.6	1.3	137
NK620W	8.0	1.2	44.4
NK630E	10.3	1.0	158
NK630W	9.3	1.0	39.2
NK820E	8.5	2.1	135
NK820W	8.5	2.1	50.2
NK840E	11.0	1.5	171
NK840W	12.0	1.5	43.8
NK860E	12.9	1.3	206
NK860V	12.9	1.3	81
NK860W	13.2	1.1	39.1

### **3.2.9. Speed ripple**

The typical speed ripple for a NK motor with a resolver at 4000rpm is 3% peak to peak. This value is given as indicative data because depending on the settings of the drive (gains of both speed and current regulation loops, presence of filtering or not, load inertia, resistant torque and type of sensor in use), without external load (neither external inertia nor resistant torque).

### **3.2.10. Cogging torque**

The typical cogging for a NK series below is the maximum value peak to peak in N.cm:

<b>Motor</b>	<b>Cogging Maxi [N.cm]</b>
NK310	2.5
NK420	4.4
NK430	5.7
NK620	5.3
NK630	6.8
NK820	9
NK840	16
NK860	20

### 3.2.11. Rated data according to rated voltage variation

The nominal characteristics and especially the rated speed, maximal speed, rated power, rated torque, depend on the nominal voltage supplying the motor considered as the rated voltage. The rated data mentioned in the data sheet are given for each association of motor and drive. Therefore, if the supply voltage changes, the rated values will also change. As long as the variation of the rated voltage remains limited, for instance  $\pm 10\%$  of the nominal value, it is possible to correctly evaluate the new rated values as illustrated below.

#### Example:

Extract of NK620EAR datasheet

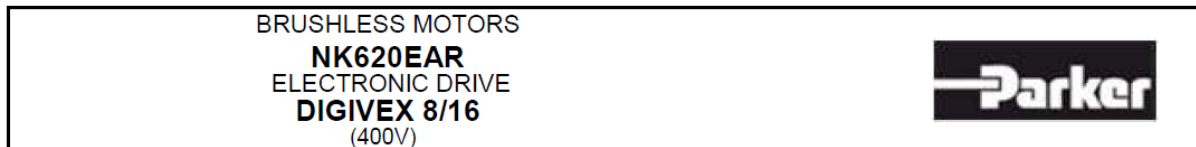

No UL certification

Torque at low speed	$M_o$	Nm	8		
Permanent current at low speed	$I_o$	$A_{rms}$	5.31		
Peak torque	$M_p$	Nm	26.7	--	
Current for the peak torque	$I_p$	$A_{rms}$	21.2	--	
Back emf constant at 1000 rpm (25°C)*	$K_e$	$V_{rms}$	95.7		
Torque sensitivity	$K_t$	Nm/ $A_{rms}$	1.51		
Winding resistance (25°C)*	$R_b$	$\Omega$	2.24		
Winding inductance*	$L$	mH	19.2		
Rotor inertia	$J$	$kgm^2 \times 10^{-5}$	98		
Thermal time constant	$T_{th}$	min	27		
Motor mass	$M$	kg	7		
Voltage of the mains	UR1 UR2 UR3	$V_{rms}$	400	-	-
Rated speed	Nn1 Nn2 Nn3	rpm	3900	-	-
Rated torque	Mn1 Mn2 Mn3	Nm	6.17	-	-
Rated current	In1 In2 In3	$A_{rms}$	4.25	-	-
Rated power	Pn1 Pn2 Pn3	W	2520	-	-

□ If we suppose that the rated voltage  $U_n=400 V_{rms}$  decreases of **10%** ; this means that the new rated voltage becomes  $U_{n2}=360 V_{rms}$ .

#### Rated speed:

The former rated speed  $N_n=3900$  rpm obtained with a rated voltage  $U_n=400 V_{rms}$  and an efficiency of  $\eta=92\%$  leads to the new rated speed  $N_{n2}$  given as follows:

$$N_{n2} = N_n * \frac{\frac{U_{n2}}{U_n} - 1 + \eta}{\eta}$$

$$N_{n2} = 3900 * \frac{\frac{360}{400} - 1 + 0.92}{0.92} = 3476rpm$$

### Maximum speed:

The former maximum speed  $N_{\max} = 3900$  rpm obtained with  $U_n = 400$  V<sub>rms</sub> and  $N_n = 3900$  rpm leads to the new maximum speed  $N_{\max 2}$  given as follows:

$$N_{\max 2} = N_{\max} * \frac{N_{n2}}{N_n} \qquad N_{\max 2} = 3900 * \frac{3476}{3900} = 3476 \text{rpm}$$

### N.B.

□ If the rated voltage increases ( $U_{n2} > U_n$ ), the new rated speed  $N_{n2}$  and the new maximum speed  $N_{\max 2}$  will be greater than the former ones  $N_n$  and  $N_{\max}$ . Moreover you will have to check that the drive still shows able to deal with the new maximum electric frequency.

	<p><u>Warning:</u> If the main supply decreases, you must reduce the maximum speed accordingly in order not damage the motor. In case of doubt, consult us.</p>
---	---

### Rated power:

The former rated power  $P_n = 2520$  W obtained with  $U_n = 400$  V<sub>rms</sub> leads to the new rated power  $P_{n2}$  given as follows:

$$P_{n2} = P_n * \frac{U_{n2}}{U_n} \qquad P_{n2} = 2520 * \frac{360}{400} = 2268 \text{W}$$

### Rated torque:

The former rated torque  $M_n = 6.17$  Nm obtained with  $U_n = 400$  V<sub>rms</sub> leads to the new rated torque  $M_{n2}$  given as follows:

$$M_{n2} = \frac{P_{n2}}{\frac{2 * \pi * N_{n2}}{60}} \qquad M_{n2} = \frac{2268}{\frac{2 * \pi * 3476}{60}} = 6.23 \text{Nm}$$

### 3.2.12. Voltage withstand characteristics of NK series

The motors fed by converters are subject to higher stresses than in case of sinusoidal power supply. The combination of fast switching inverters with cables will cause overvoltage due to the transmission line effects. The peak voltage is determined by the voltage supply, the length of the cables and the voltage rise time. As an example, with a rise time of 200 ns and a 30 m (100 ft) cable, the voltage at the motor terminals is twice the inverter voltage.

The insulation system of the servomotors NK is designed to withstand high repetitive pulse voltages and largely exceeds the recommendations of the IEC/TS 60034-25 ed 2.0 2007-03-12 for motors without filters up to 500V AC (See figure 1).

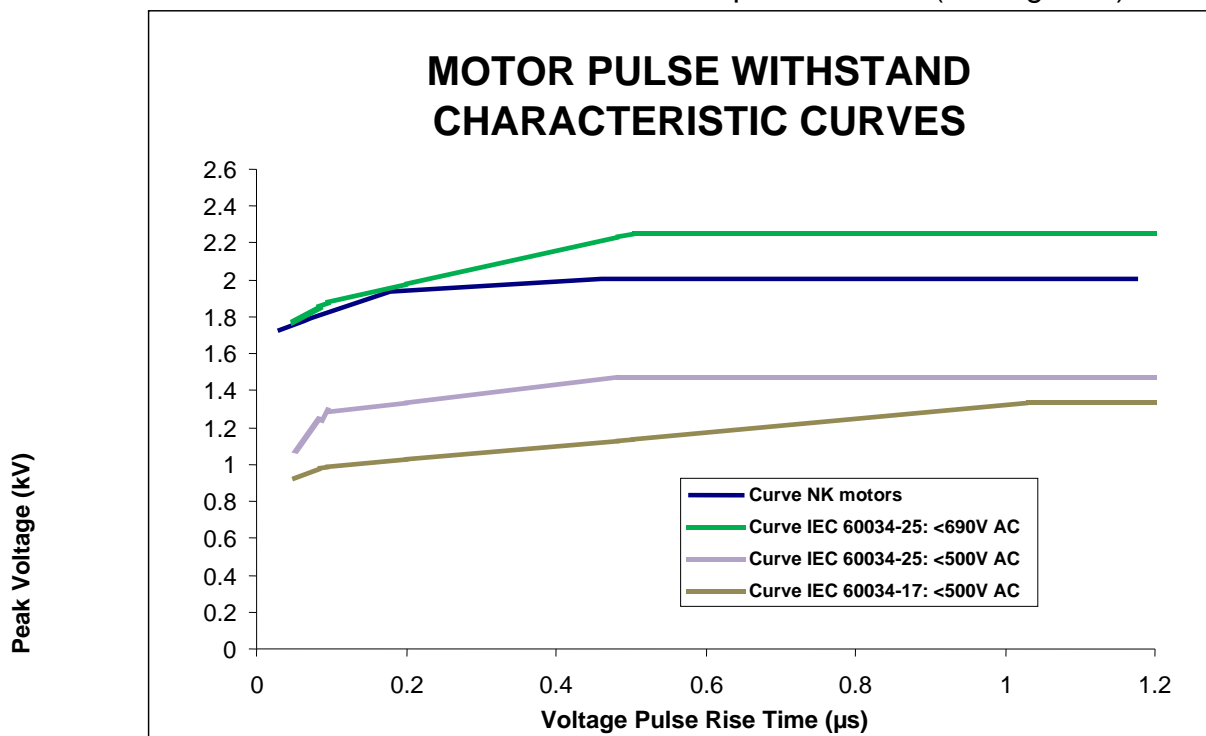

Figure 1: Minimum Voltage withstands characteristics for motors insulations according to IEC standards. At the top are the typical capabilities for the NK motors.

Note: The pulse rise times are defined in accordance with the IEC/TS 60034-17 ed4.0 2006-05-09.

The NK motors can be used with a supply voltage up to 500 V under the following conditions:

- The pulse rise times must be longer than 50 ns.
- The repetitive pulse voltages must not exceed the values given in figure 1, “Curve NK motors” in dark blue.

### 3.3. Dimension drawings

#### 3.3.1. NK3

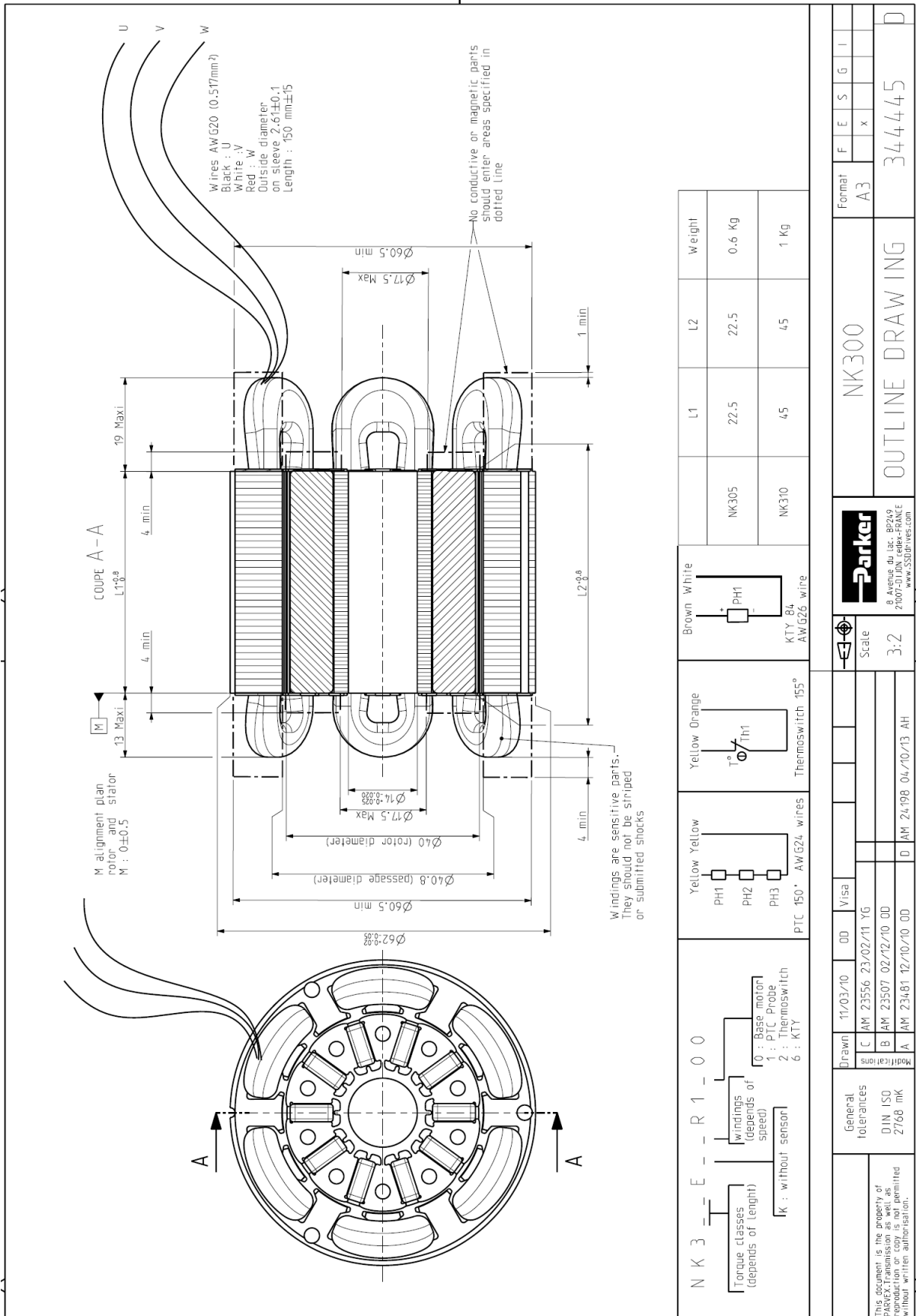

**3.3.2. NK4**

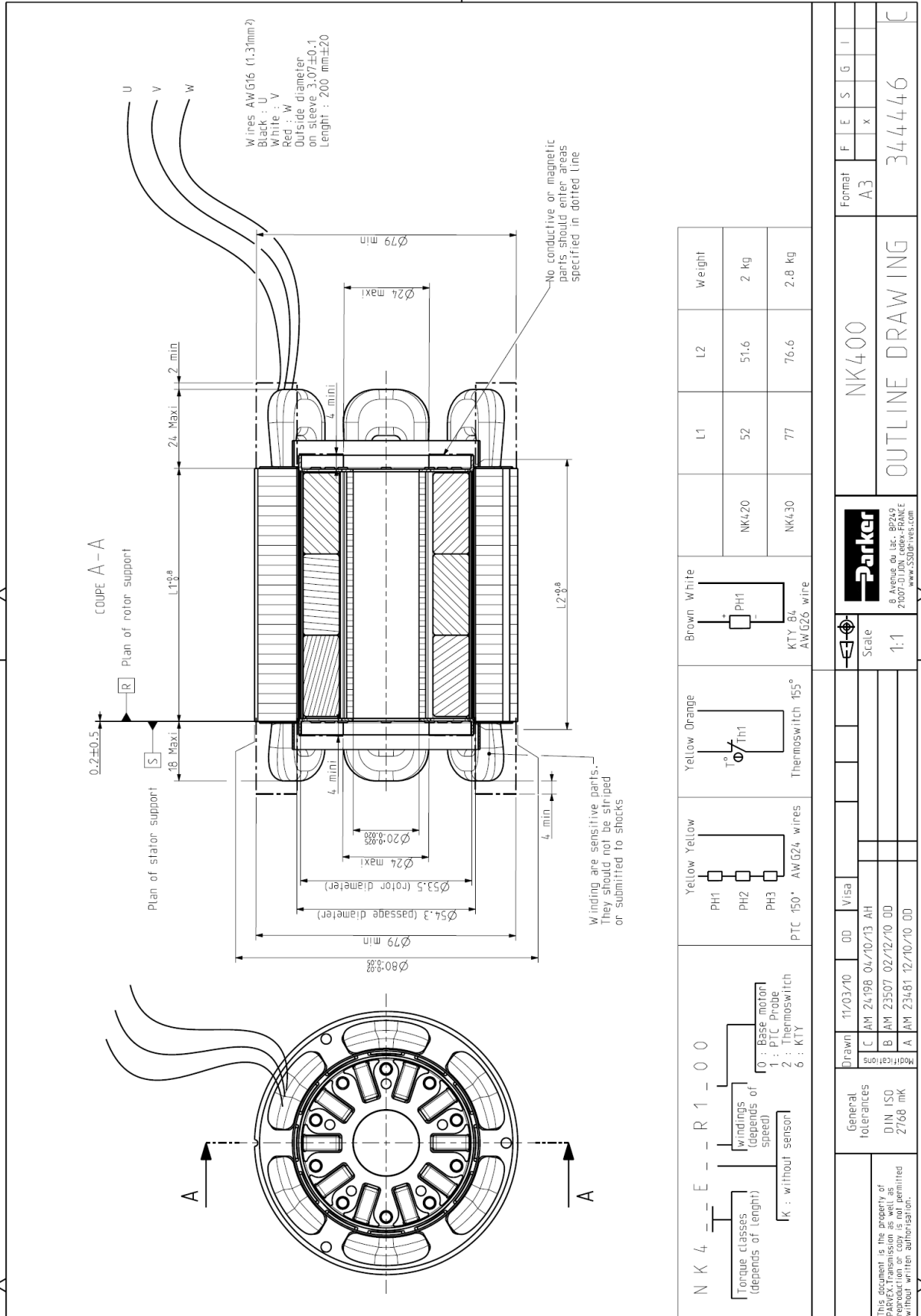



## 3.3.3. NK6

Wires AWG16 (1.3mm<sup>2</sup>)  
 Black: U  
 White: V  
 Red: W  
 Outside diameter on sleeve 3.07±0.1  
 Length : 150 mm±F5

U  
 V  
 W

0.2±0.5

20 Maxi

5 min

4 min

26 Maxi

4 min

L1 90.8

L2 80.8

Ø111.8±0.05

Ø71.8 (passage diameter)

Ø71 (rotor diameter)

Ø32 Max

Ø26.8±0.025

Ø108 min

Ø32 Max

Ø108 min

Plan of stator support

Plan of rotor support

Coupé A-A

Wires are sensitive parts. They should not be striped or submitted to shocks.

No conductive or magnetic part shall enter areas specified in dotted line.

Yellow Yellow	PH1	PH2	PH3	PTC 150° AWG24 wires
Yellow Orange				Thermoswitch 155°
Brown White				KTY 84 AWG26 wire

	L1	L2	Weight
NK620	60	59.6	4.3 kg
NK630	89	88.6	6 kg

**N K 6 E - R 1 - 0 0**

- Torque classes (depends of length)      [K : without sensor]
- Windings (depends of speed)      [0 : Base motor]

1 : PTC Probe  
 2 : Thermoswitch  
 6 : KTY

Drawn: 11/03/10

00

11/03/10    04/10/13 AH

AM 23507    02/12/10 OD

AM 23481    12/10/10 OD

00

00

12/10/10

12/10/10

General tolerances

DIN ISO 2768 mK

This document is the property of PARKER Transmission as well as PARKER France. It is not to be disseminated without written authorization.

Scale: 1:1

State:

Format: A3

344447

NK600

OUTLINE DRAWING

Format: F E S G I

A3

x

344447

### 3.3.4. NK8

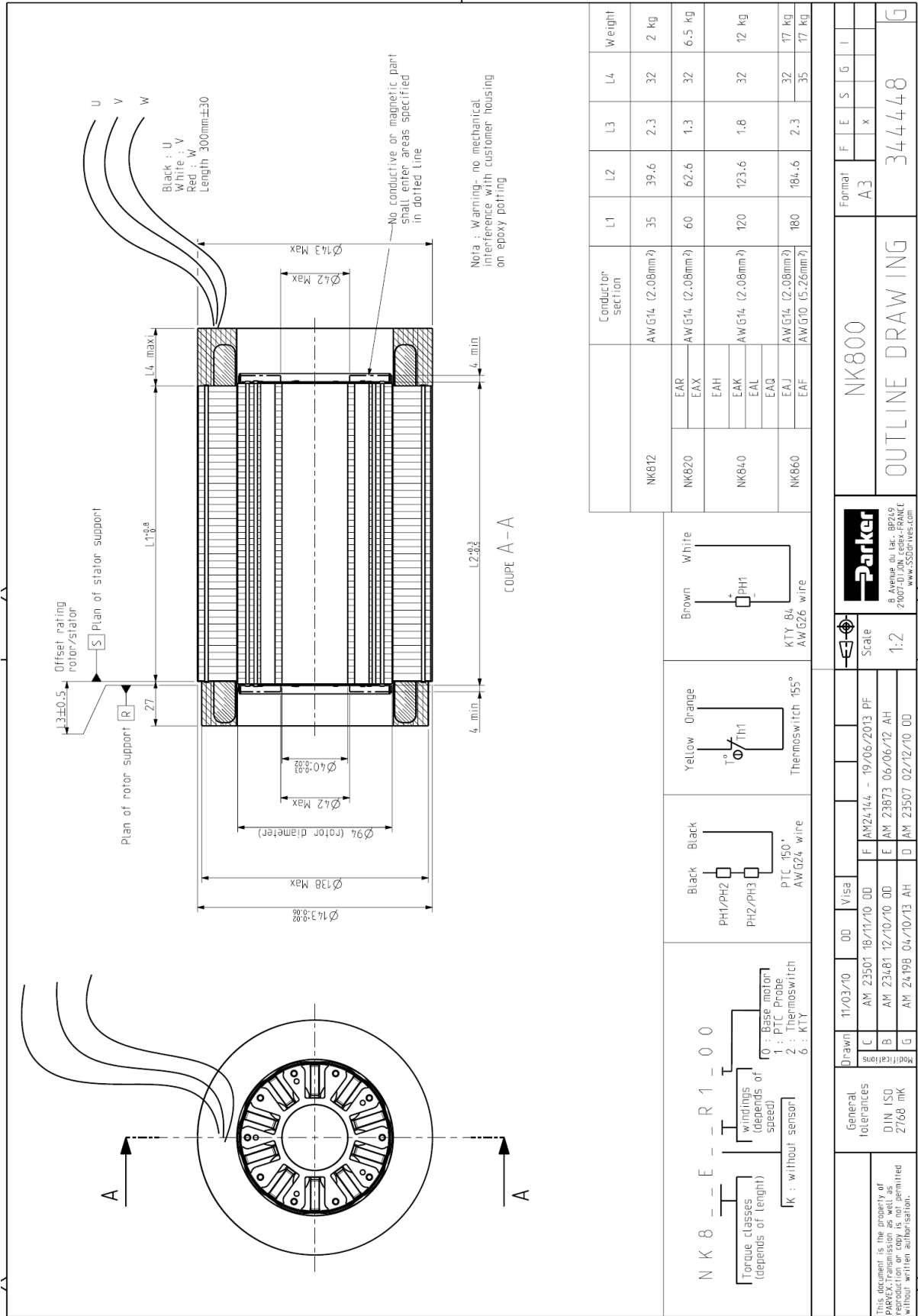

Conductor section	L1	L2	L3	L4	Weight
	NK812	35	39.6	2.3	32
NK820	EAR	60	62.6	32	6.5 kg
	EAX				
NK840	EAH	120	1.8	32	12 kg
	EAK				
	EAL				
	EAG				
NK860	EAJ	180	2.3	32	17 kg
	EAF			35	17 kg

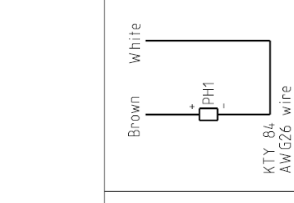

Drawn	11/03/10	OD	Visa
C	AM 23501 18/11/10 OD	F	AM24144 - 19/06/2013 PF
B	AM 23481 12/10/10 OD	E	AM 23873 06/06/12 AH
G	AM 24198 04/10/13 AH	D	AM 23507 02/12/10 OD

General tolerances	DIN ISO 2768 mK
This document is the property of PARKER. Transmission as well as publication without written authorisation.	

6 Avenue du Lac - BP219  
21007 - JOZEY - FRANCE  
www.555parker.com

Scale 1:2

Format A3

NK800

OUTLINE DRAWING

344448

G

### 3.3.1. NK3..W

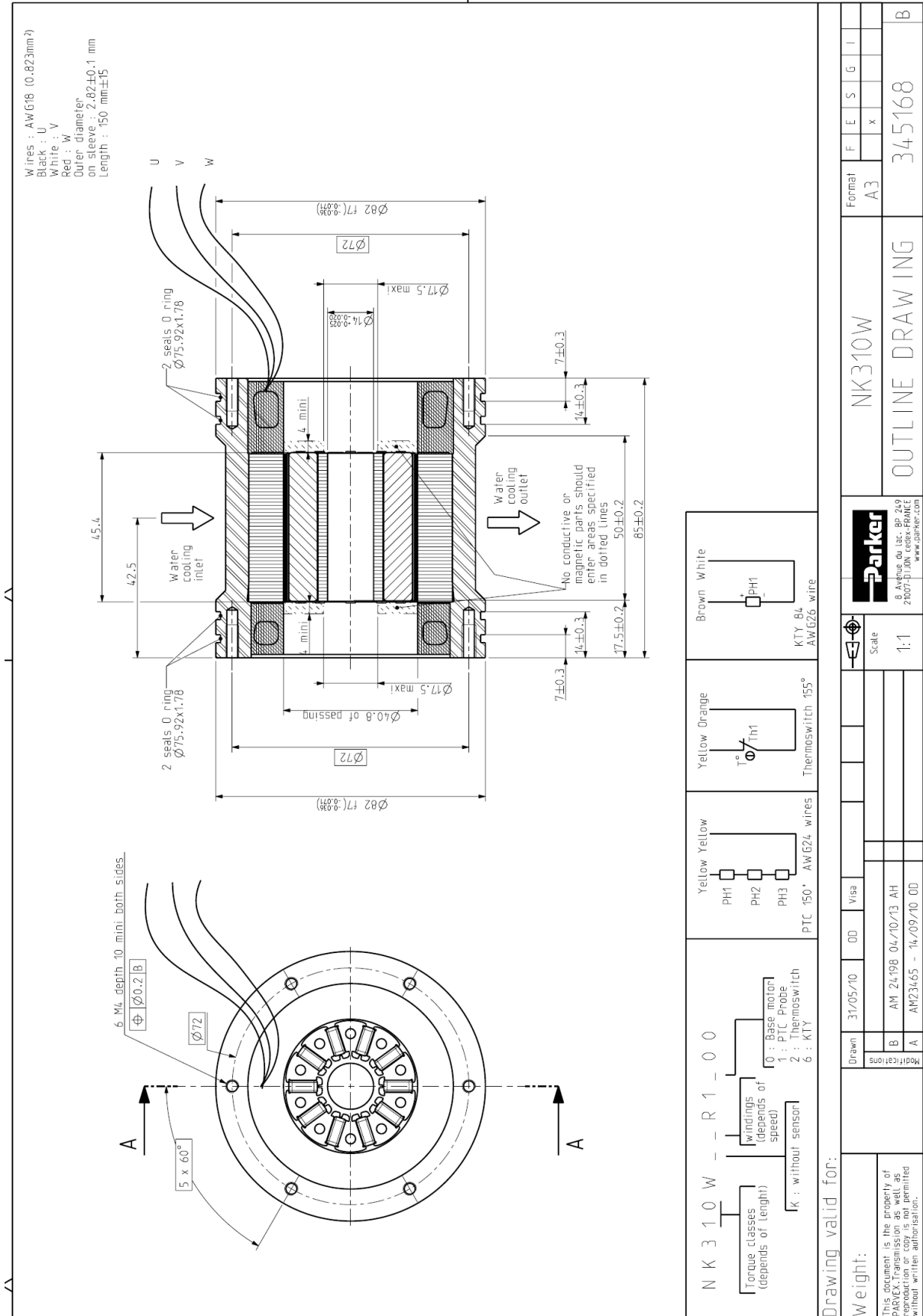

### 3.3.2. NK4..W

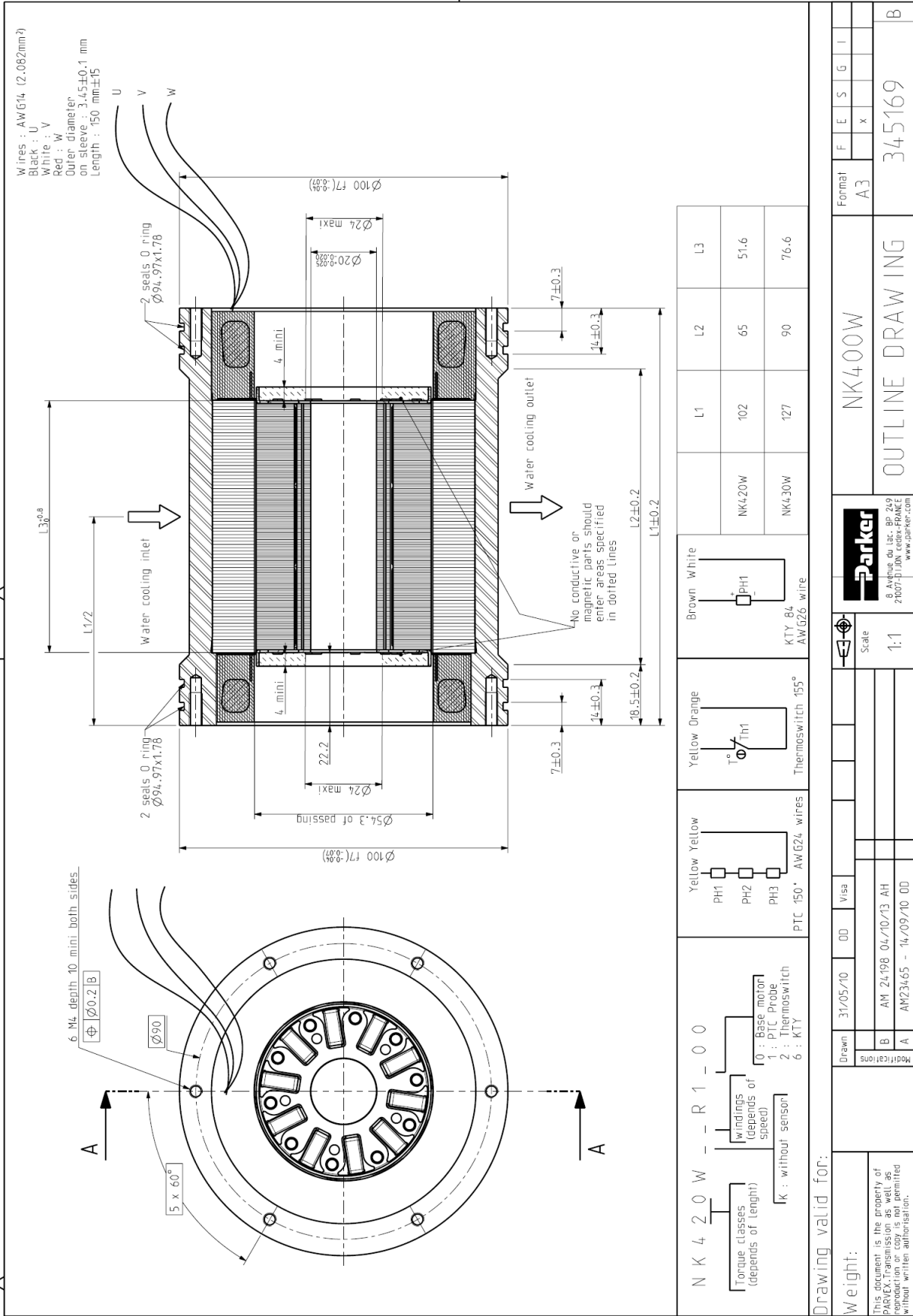

### 3.3.3. NK6..W

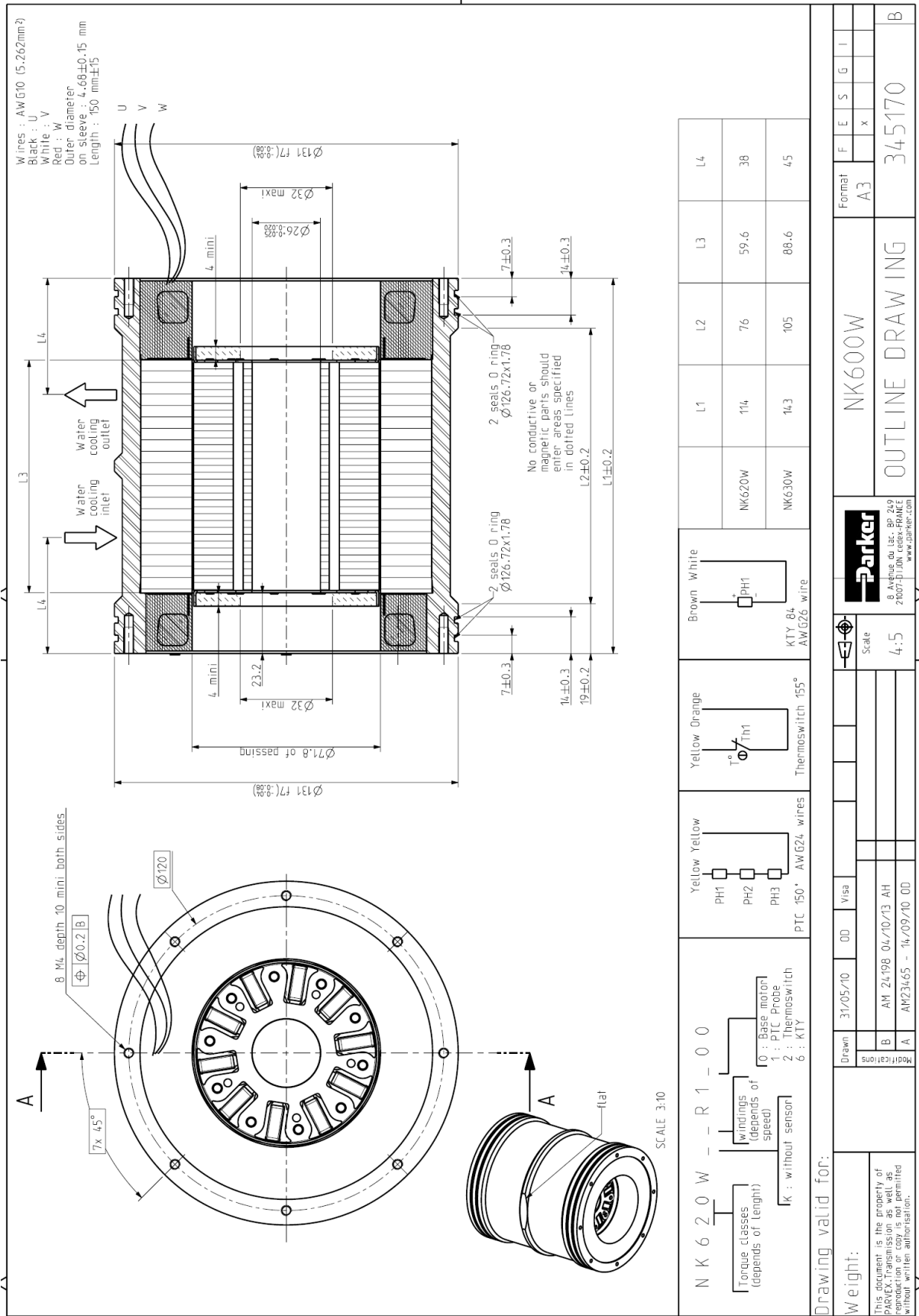



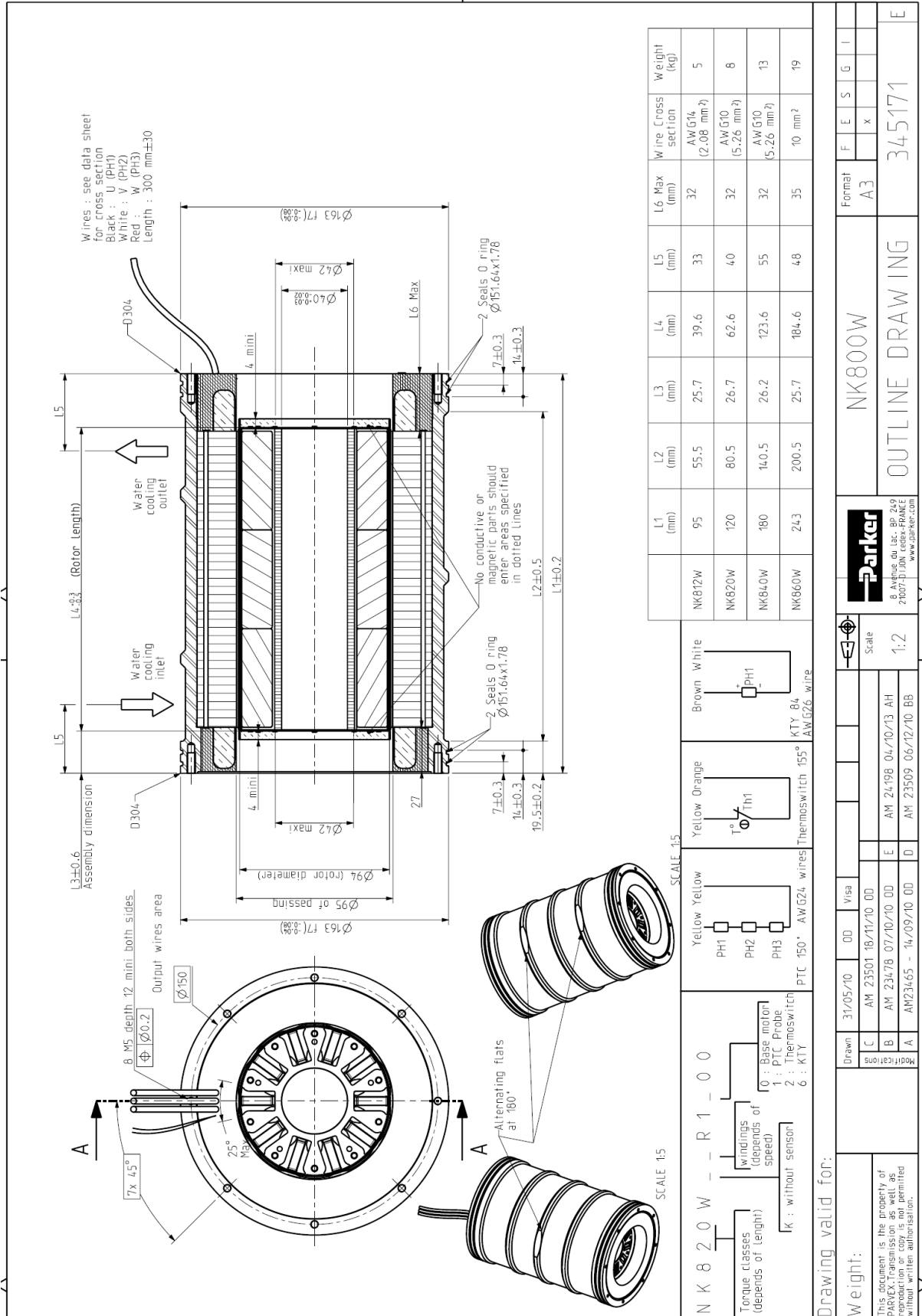

### 3.3.4. NK8..W



### 3.4. Motor mounting recommendations

	<p><u>Warning</u> : The recommendations in this chapter are general. It is the integrator responsibility to check if it complies with his application and to chose and define the correct way to integrate the kit according to his application, all the regulations and standards applicable.</p>
---	--

#### 3.4.1. Frame recommendation

	<p><u>Warning</u> : The user has the entire responsibility to design and prepare the housing, the shaft, connection box, the support, the coupling device, shaft line alignment, and shaft line balancing.</p>
---	--

Machine design must be even, sufficiently rigid, precise and shall be dimensioned as to avoid vibrations due to resonances. Integrator bears the entire responsibility for choice of the key components, such as bearing, encoder, electric connection and mechanical parts design.

	<p><u>Warning</u> : A grade A motor (according to IEC 60034-14) well-balanced, may exhibit large vibrations when installed in-situ arising from various causes, such as unsuitable foundations, reaction of the driven motor, current ripple from the power supply, etc. Vibration may also be caused by driving elements with a natural oscillation frequency very close to the excitation due to the small residual unbalance of the rotating masses of the motor. In such cases, checks should be carried out not only on the machine, but also on each element of the installation. (See ISO 10816-3).</p>
---	--

	<p><u>Warning</u> : A bad setting of the electronic control of the close loop (gain too high, incorrect filtering ...) can occur an instability of the shaft line, vibration or/and breakdown - . Please consult us</p>
---	---

### 3.4.2. Servomotor typical construction

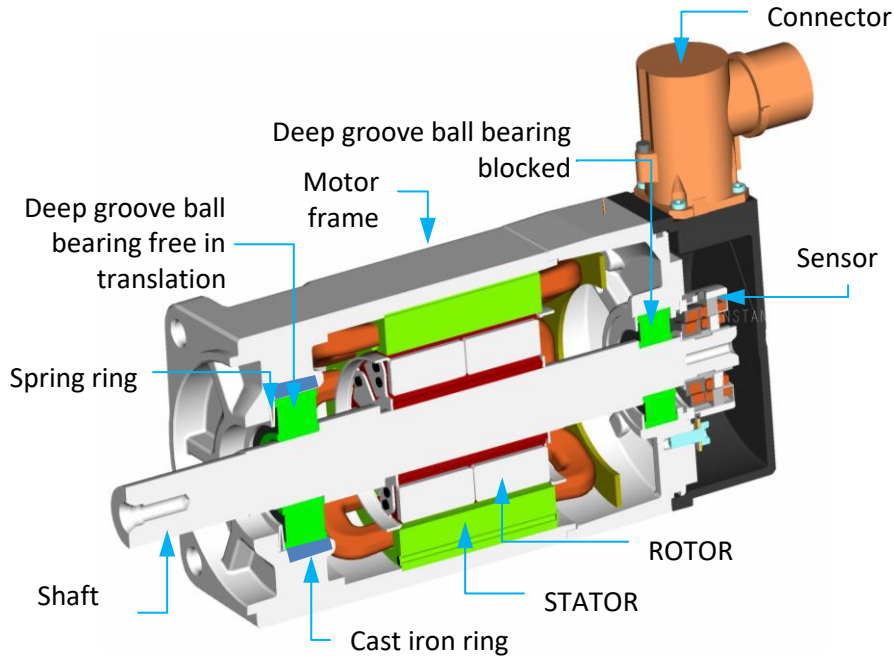

### 3.4.3. Bearings recommendation

The arrangement bearings choice is a key point for the motor design. It depends on speed, load and life time needed. We recommend to contact bearing supplier technical department to check the arrangement.

	<p><u>Warning</u> : When motor runs, the temperature increases (up to 120°C on the rotor), so use springs or spring rings on one bearing to accept shaft dilatation and to create a preload..</p> <div style="text-align: center;"> </div>
--	--

	<p><u>Warning</u> : When motor runs, temperature increases (up to 120°C on the rotor), so we recommend to use bearings with C3 clearance..</p>
--	--



### 3.4.4. Mechanical interfaces

The mechanical interfaces requirements for the user structure must comply with the following drawings and values.

#### 3.4.4.1. Rotor interfaces

To fit the rotor on the shaft, apply a force (F<sub>maxi</sub> from the following tab) with a press near the center with a no magnetic part.

To decrease the force applied, it is possible to heat the rotor up to 130°C maxi.

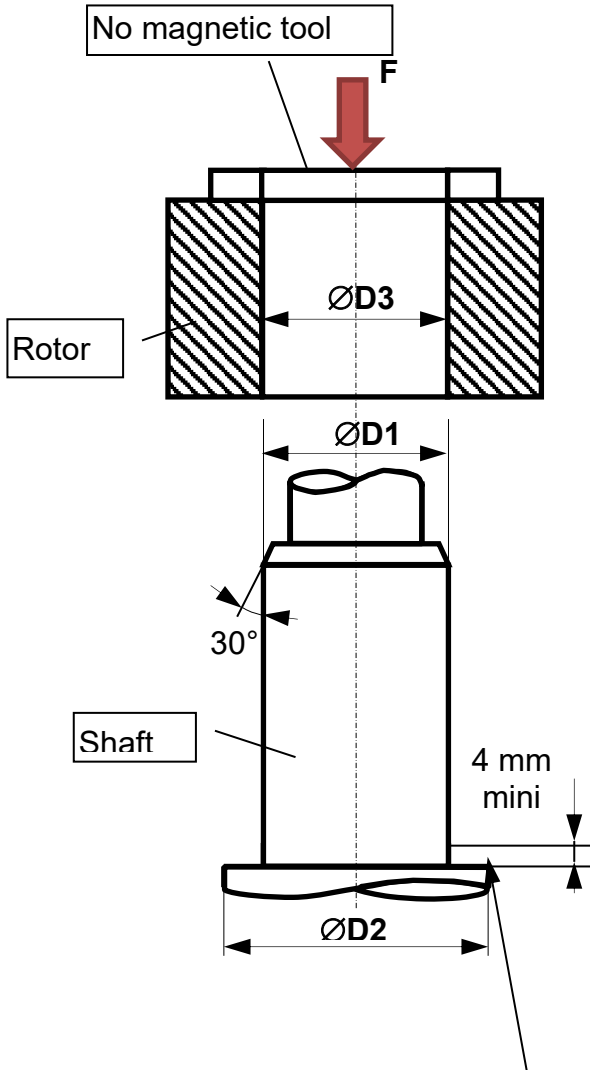

Moteur	D1	D2 max	D3	F maxi ( kN )
NK310	14 s6	17.5	14 <sup>+0.025</sup> <sub>-0.02</sub>	13
NK420	20 s6	24	20 <sup>+0.025</sup> <sub>-0.02</sub>	53
NK430	20 s6	24	20 <sup>+0.025</sup> <sub>-0.02</sub>	80
NK620	26 s6	32	26 <sup>+0.025</sup> <sub>-0.02</sub>	75
NK630	26 s6	32	26 <sup>+0.025</sup> <sub>-0.02</sub>	113
NK820	40 t6	48	40 <sup>+0.03</sup> <sub>-0.02</sub>	54
NK840	40 t6	48	40 <sup>+0.03</sup> <sub>-0.02</sub>	110
NK860	40 t6	48	40 <sup>+0.03</sup> <sub>-0.02</sub>	165



Warning : The rotor must not touch the step D2 to avoid shaft flexion

### 3.4.4.2. Natural cooled stator interfaces

The stator can be shrink fitted inside an aluminium housing (with a yield strength >160 Mpa), or a steel housing (with a yield strength > 350Mpa), or stainless steel housing (with a yield strength > 290Mpa).

The housing has to be heated at 250°C to 300°C and the stator inserted in the housing.

The tab below show the main housing dimensions. :

Motor	D1 for aluminum Re>160Mpa	D1 for steel Re>350Mpa	D1 for stainless steel Re>290	D2 mini	D3 mini	Ø Stator	L mini
NK3	62 <sup>-0.120</sup> <sub>-0.150</sub>	62 <sup>-0.060</sup> <sub>-0.090</sub>	62 <sup>-0.080</sup> <sub>-0.110</sub>	70	60.5	62 <sup>+0.02</sup> <sub>-0.05</sub>	17
NK4	80 <sup>-0.140</sup> <sub>-0.170</sub>	80 <sup>-0.060</sup> <sub>-0.090</sub>	80 <sup>-0.090</sup> <sub>-0.120</sub>	90	79	80 <sup>+0.02</sup> <sub>-0.05</sub>	22
NK6	111 <sup>-0.175</sup> <sub>-0.210</sub>	111 <sup>-0.060</sup> <sub>-0.095</sub>	111 <sup>-0.105</sup> <sub>-0.140</sub>	120	107	111 <sup>+0.02</sup> <sub>-0.05</sub>	25
NK8	143 <sup>-0.215</sup> <sub>-0.255</sub>	143 <sup>-0.070</sup> <sub>-0.110</sub>	143 <sup>-0.130</sup> <sub>-0.170</sub>	155	138	143 <sup>+0.02</sup> <sub>-0.06</sub>	29

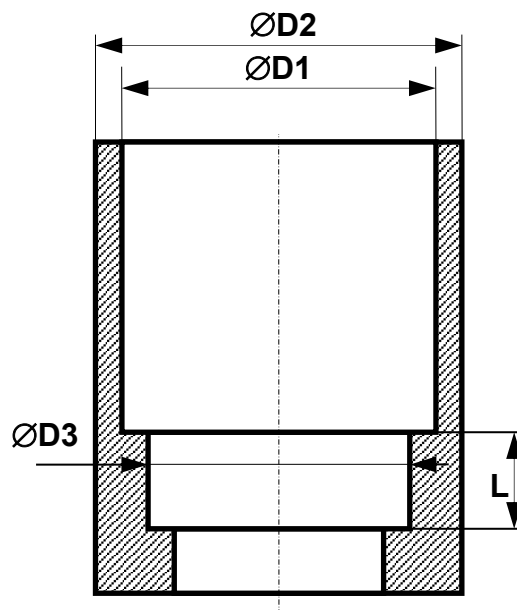

	<p><u>Warning</u> : D3 and L give the place for the end winding. Respect the spacing indicated in the outline drawing or add an insulation sheet between the end winding and the housing.</p>
	<p><u>Warning</u> : the complete motor must thermally well connected to a aluminium flange with the minimal surface (see § 3.5.1. Natural and fan cooled motor)</p>

### 3.4.4.3. Water cooled stator interfaces

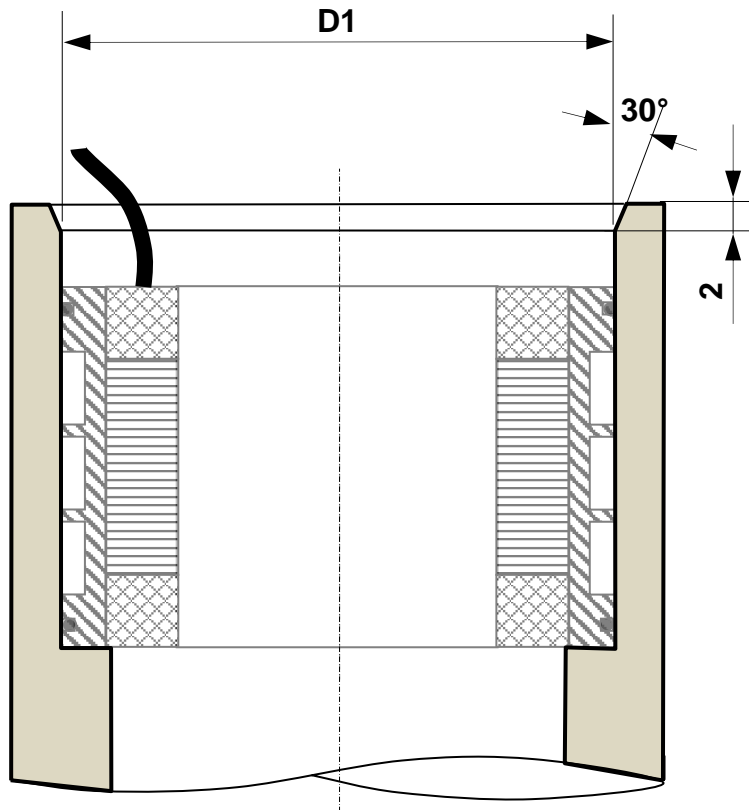



Motor	D1 (mm)
NK3	82H8
NK4	100H8
NK6	131H8
NK8	163H8

### 3.4.5. Water cooled version recommendations

#### 3.4.5.1. O-ring recommendations

The cooling circuit is sealed by four O-rings seal between stator and user's housing.

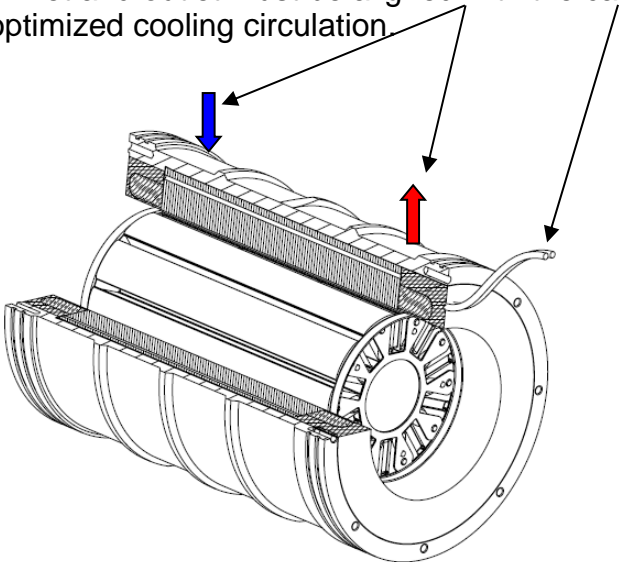
	<p><u>Caution:</u> The 2 O-rings must be greased with an ordinary lubricant before mounting to avoid damages and leakages.</p>
	<p><u>Caution:</u> Be careful not to make damage on the O-ring during the mounting to avoid leakage. It's recommended to realize a waterproof test with 5 bars air pressure during 30 minutes and check if there is not pressure decreasing.</p>
	<p><u>Caution:</u> Water inlet and outlet must be aligned with the cables inlet to guarantee an optimized cooling circulation.</p> 

Motor	O-ring diameter (mm)	Cross section (mm)	Material	Hardness	Working temperature (°C)	PARKER part number
NK3	75.92	1.78	NBR	70 shores	-25 / +120	5340P0069
NK4	94.97	1.78	NBR	70 shores	-25 / +120	5340P0081
NK6	126.72	1.78	NBR	70 shores	-25 / +120	5340P0077
NK8	151.64	1.78	NBR	70 shores	-25 / +120	5340P0093

#### 3.4.5.2. Condensation water drain hole

Condensation and risk of rust may occur when the temperature gradient between the air and the water becomes significant, so drain holes must be integrated on the frame design. These holes must be positioned at the lowest point in the motor housing.

Condensation water drain holes must be checked at least once a year

### **3.4.6. Design Compliance**

The integrator is responsible for compliance with directives, regulations and standards. Nonexhaustively, the integrator has to certify the complete motor design in order to be conformed to the guide lines (nonexhaustively).

- Low Voltage Directive      2014/35/EU
- RoHs Directive                2011/65/CE
- EMC Directive                 2004/108/CE

The complete motor must comply with the IEC60034 standard  
The heating of the complete motor must meet the requirements of the class F insulation (cf. IEC 60034-1)

### **3.4.7. Dielectric test**

Each complete motor must undergo once completely, a dielectric test (Routine test) in accordance with the standard IEC 60034-1 (i.e. 1500 V during 1 min for 230 Vac).

### **3.4.8. Earthing**

A protective earth cable with the appropriate cable diameter must connect the complete motor stator to the grounding (cf. standards: NF C15-100, CEI 60364-1, IEC 60204-1).

Section of phases conductors, $S$ [mm <sup>2</sup> ]	Corresponding minimal cross-section of earthing conductor, $S_p$ [mm <sup>2</sup> ]
$S \leq 16$	$S$
$16 < S \leq 35$	16
$S > 35$	$0.5S$

### **3.4.9. Minimum clearances for insulation and creepage distances**

Depending on the pollution degree and the voltage in use, the minimum clearances for insulation and creepage distances must meet the standard EN 60664-1.

It is the integrator's responsibility to take the needed actions to comply with these distances or by adding proper additional insulation.

***For information:***

- *Pollution degree 1.* No pollution or only dry, nonconductive pollution occurs. The pollution has no influence (example: sealed or potted products).
- *Pollution degree 2.* Normally only nonconductive pollution occurs. Occasionally a temporary conductivity caused by condensation must be expected (example: product used in typical office environment).
- *Pollution degree 3.* Conductive pollution occurs, or dry, nonconductive pollution occurs that becomes conductive due to expected condensation (example: products used in heavy industrial environments that are typically exposed to pollution such as dust).
- *Pollution degree 4.* Pollution generates persistent conductivity caused, for instance, by conductive dust or by rain or snow.



**Minimum clearances for insulation:**

Voltage rms	Required impulse withstand voltage V	Minimum clearances in air in millimeters up to 2000 m above sea level							
		Case A (inhomogeneous field)				Case B (homogeneous field)			
		Pollution degree				Pollution degree			
		1 mm	2 mm	3 mm	4 mm	1 mm	2 mm	3 mm	4 mm
50V	600	0,06	0,2	0,8	1,6	0,06	0,2	0,8	1,6
from 100V to 250V	1500	0,5	0,5	0,8	1,6	0,3	0,3	0,8	1,6
up to 500V	2000	1	1	1	1,6	0,45	0,45	8	1,6

N.B. Please refer to the standard EN 60664-1 for more information.

**Minimum creepage distances for equipment subject to long-term stresses**

Voltage rms	Creepage distances in millimeters									
	Pollution degree									
	1	2 Material group			3 Material group			4 Material group		
	mm	I mm	II mm	III mm	I mm	II mm	III mm	I mm	II mm	III mm
50	0,18	0,6	0,85	1,2	1,5	1,7	1,9	2	2,5	3,2
100	0,25	0,71	1	1,4	1,8	2	2,2	2,4	3	3,8
160	0,32	0,8	1,1	1,6	2	2,2	2,5	3,2	4	5
200	0,42	1	1,4	2	2,5	2,8	3,2	4	5	6,3
250	0,56	1,25	1,8	2,5	3,2	3,6	4	5	6,3	8
320	0,75	1,6	2,2	3,2	4	4,5	5	6,3	8	10
400	1	2	2,8	4	5	5,6	6,3	8	10	12,5
500	1,3	2,5	3,6	5	6,3	7	8	10	12,5	16

N.B. Please refer to the standard EN 60664-1 for more information.

**3.4.10. Ground continuity compliance**

The complete motors must meet the standards IEC 60204-1.

Continuity of the grounding circuit : On each complete unit, the resistance between any conductive point and the grounding conductor shall not exceed than 100 mΩ. This test shall be performed before the dielectric tests. (EN 60204-1: Safety of the machine)

**3.4.11. Protection rating**

cf. IEC 60529 and IEC 60034-5

The frameless motors show an IP00 protection rating. It is the integrator's responsibility to ensure the appropriate protection rating depending on the use of the complete motor (protection against electric shocks of persons, protection against dust, liquids, solid particles, ...)

#### **3.4.12. Overspeed test**

A qualification test at 20% above the rated speed during at least 1 min, must be carried out according to the standard IEC 60034-1.

#### **3.4.13. EMC Directive**

cf. guide lines 2004-108 CE and standard IEC 61800-3

It is the integrator's responsibility to ensure that the complete motor and drive in use comply with the EMC directive.

#### **3.4.14. Other requirements**

The previous list is not exhaustive and all the other requirements in the regulation standard and directives must be checked by the integrator.

### 3.5. Cooling

In compliance with the IEC 60034-1 standards:

#### 3.5.1. Natural and fan cooled motor

The ambient air temperature shall not be less than **-15°C** and more than **40°C**.

	<p>NK Series are housed in a motor frame detailed in § 3.4.4.2. Natural cooled stator interfaces</p>
---	--







	<p><u>Warning:</u> To reach the motor performances calculated, the complete motor must thermally well connected to a aluminium flange with the following surface:</p> <ul style="list-style-type: none"> <li>- <b>NK310:</b> 265 cm<sup>2</sup></li> <li>- <b>NK420:</b> 395 cm<sup>2</sup></li> <li>- <b>NK430:</b> 580 cm<sup>2</sup></li> <li>- <b>NK620:</b> 630 cm<sup>2</sup></li> <li>- <b>NK630:</b> 935 cm<sup>2</sup></li> <li>- <b>NK820:</b> 810 cm<sup>2</sup></li> <li>- <b>NK840:</b> 1620 cm<sup>2</sup></li> <li>- <b>NK860:</b> 2430 cm<sup>2</sup></li> <li>-</li> </ul>
---	---

	<p><u>Caution:</u> the ambient air temperature shall not exceed 40°C in the vicinity of the motor flange</p>
---	--

	<p><u>Warning:</u> A significant part of the heat produced by the motor is evacuated through the flange.</p> <ul style="list-style-type: none"> <li>• if the air is not able to circulate freely around the motor,</li> <li>• if the motor is mounted on a surface that dissipates not well the heating (surface with little dimensions for instance),</li> <li>• if the motor is thermally isolated,</li> <li>• if the motor is mounted on a warm surface (mounted on a gearbox for instance),</li> </ul> <p>then the motor has to be used at a torque less than the rated torque.</p>
---	---



### 3.5.2. Water cooled motor

	<p><u>Danger:</u> The cooling system has to be operational when the motor is running or energized.</p>
	<p><u>Danger:</u> The Inlet temperature and the water flow have to be monitored to avoid any exceeding temperature values.</p>
	<p><u>Caution:</u> When motor is not running, the cooling system has to be stopped 10 minutes after motor shut down.</p>
	<p><u>Caution:</u> Condensation and risk of rust may occur when the temperature gradient between the air and the water becomes significant. Condensation is also linked to hygrometry rate. To avoid any issue, we recommend: <math>T_{\text{water}} &gt; T_{\text{air}} - 2^{\circ}\text{C}</math>. The motor can be used with an ambient temperature between 27°C to 40°C with a high water temperature but with derating. If inlet water temperature becomes higher than 25°C, derating factor must be applied according to §3.1.2 Temperature Derating</p>
	<p><u>Caution:</u> the ambient air temperature shall not exceed 40°C in the vicinity of the motor flange</p>
	<p><u>Danger:</u> If the water flow stops, the motor can be damaged or destroyed causing accidents.</p>

### 3.5.3. Additives for water as cooling media

Please refer to motor technical data for coolant flow rates.

The water inlet temperature must not exceed **25°C** without torque derating.  
The water inlet temperature must not be below **5°C**.

The inner pressure of the cooling liquid must not exceed **5 bars**.

	<p><u>Caution:</u> To avoid the appearance of corrosion of the motor cooling system, the water must have anti-corrosion additive.</p>
---	---

The servomotors are water cooled. Corrosion inhibitors must be added to the water to avoid the corrosion. The complete cooling system must be taken into account to choose the right additive, this includes: the different materials in the cooling circuit, the chiller manufacturer recommendations, the quality of the water...

The right additive solution is under the responsibility of the user. Some additives like TYFOCOR or GLYSANTIN G48 correctly used have demonstrated their ability to prevent corrosion in a closed cooling circuit.

For example: Glysantin G48 recommendations are :

- Water hardness: 0 to 20°dH (0 – 3.6 mmol/l)
- Chloride content: max. 100ppm
- Sulphate content: max. 100ppm

	<p><u>Caution:</u> The water quality is very important and must comply with supplier recommendations. The additive quantity and periodic replacement must respect the same supplier recommendations.</p>
---	--

	<p><u>Caution:</u> The additive choice must take into account the global cooling system (chiller or water exchanger recommendations...).</p>
---	--

	<p>Select carefully the materials of all the cooling system parts (chiller, exchanger, hoses, adapters and fittings) because the difference between material galvanic potential can make corrosion.</p>
---	---



### **3.5.4. Motor cooling circuit drop pressure**

The tab below describes the drop pressure at the water flow rate from the motor data:

<b>Motor type</b>	<b>Drop pressure</b>
All NK...W	0.5 bar

Note : all motors drop pressure are checked before shipping.

### **3.5.5. Chiller selection**

This section describes how to choose the chiller. The chiller is able to evacuate the heat from the motor losses with the water circulation.

The motor losses (= power to evacuate by the chiller) depend on the efficiency and motor power:

$$P_c = \left( \frac{1}{\rho} - 1 \right) \cdot P_n$$

With  $P_c$  : Power to evacuate by the chiller (kW)  
 $P_n$  : Nominal motor power (kW)  
 $\rho$  : motor efficiency at nominal power (%)

Refer to the respective motor data sheet for nominal power, efficiency and water flow. Chiller pump must provide water flow through motor and pipe pressure drop. Inlet temperature must be inferior to **25°C**.

#### **Example**

*Motor : NK860W*

*For a torque of 80 N.m @ 2500 rpm, the efficiency is 92%.*

*Water flow = 5 l/min*

$$P_n = 80 \times 2500 \times \pi / 30$$

$$P_n = 20.9 \text{ kW}$$

$$P_c = \left( \frac{1}{0.92} - 1 \right) \cdot 20.9 = \mathbf{1.8 \text{ kW}}$$

*So, the chiller must evacuate 1.8 kW and has a water flow of 5 l/min for this point of running.*

### 3.5.6. Flow derating according to glycol concentration

	Glycol concentration [%]					
	0	10	20	30	40	50
5	5.1	5.3	5.6	5.9	6.2	
10	10.2	10.6	11.1	11.8	12.4	
15	15.3	15.9	16.7	17.6	18.7	
20	20.4	21.2	22.2	23.5	24.9	
25	25.5	26.5	27.8	29.4	31.1	
30	30.6	31.8	33.4	35.3	37.3	
35	35.7	37.1	38.9	41.1	43.6	
40	40.8	42.4	44.5	47.0	49.8	
45	45.9	47.7	50.0	52.9	56.0	
50	51.0	53.0	55.6	58.8	62.2	
55	56.1	58.3	61.2	64.7	68.4	
60	61.2	63.5	66.7	70.5	74.7	
65	66.4	68.8	72.3	76.4	80.9	
70	71.5	74.1	77.8	82.3	87.1	
75	76.6	79.4	83.4	88.2	93.3	
80	81.7	84.7	89.0	94.1	99.5	
85	86.8	90.0	94.5	99.9	105.8	
90	91.9	95.3	100.1	105.8	112.0	
95	97.0	100.6	105.6	111.7	118.2	
100	102.1	105.9	111.2	117.6	124.4	
110	112.3	116.5	122.3	129.3	136.9	
120	122.5	127.1	133.4	141.1	149.3	
130	132.7	137.7	144.6	152.8	161.8	
140	142.9	148.3	155.7	164.6	174.2	
150	153.1	158.9	166.8	176.3	186.6	
160	163.3	169.5	177.9	188.1	199.1	
170	173.5	180.1	189.0	199.9	211.5	
180	183.7	190.6	200.2	211.6	224.0	
190	194.0	201.2	211.3	223.4	236.4	
200	204.2	211.8	222.4	235.1	248.9	

**Use of the table above - Example**

If the motor needs **25 l/min** with **0%** glycol,

If application needs **20%** glycol, the water flow must be **26.5 l/min**,

If application needs **40%** glycol, the water flow must be **29.4 l/min**.



### Main formulas

$$Flow\_rate = \frac{Power\_dissipation * 60}{\Delta\theta * C_p}$$

With: *Flow rate* [l/min]  
*Power\_dissipation* [W]  
 $\Delta\theta$  Gradient inlet-outlet [°C]  
**C<sub>p</sub>** thermal specific capacity of the water as coolant [J/kg°K]  
(**C<sub>p</sub>** depends on the % glycol concentration please see below)

### Thermal specific capacity C<sub>p</sub> according to % glycol concentration and temperature

We have considered an average temperature of the coolant of 30°C.

Glycol concentration [%]	Average temperature of the water as coolant [°C]	Thermal specific capacity of the water <b>C<sub>p</sub></b> [J/kg°K]
0	30	4176
30	30	3755
40	30	3551
50	30	3354

### 3.5.7. Water cooling diagram

	<p><u>Recommendation:</u> The use of a filter allows to reduce the presence of impurities or chips in the water circuit in order to prevent its obstruction. We recommend 0.1mm filter.</p>
--	---

This section shows typical water cooling diagram :

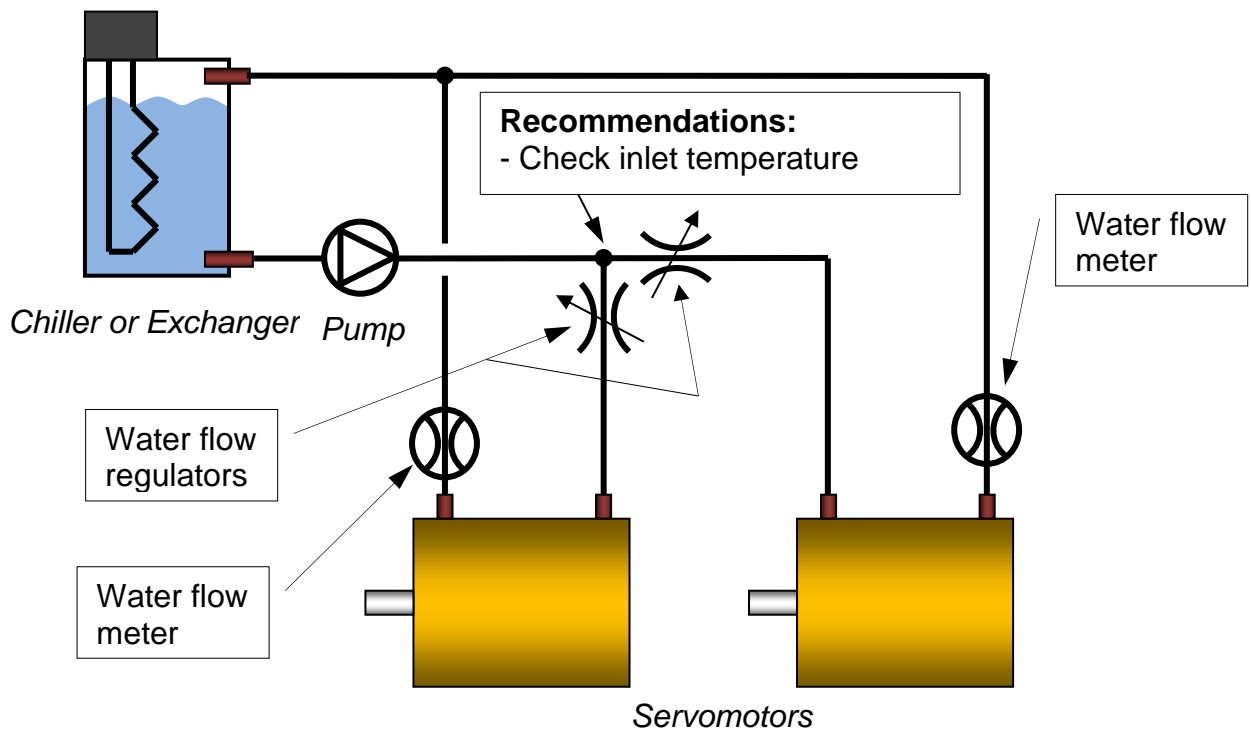
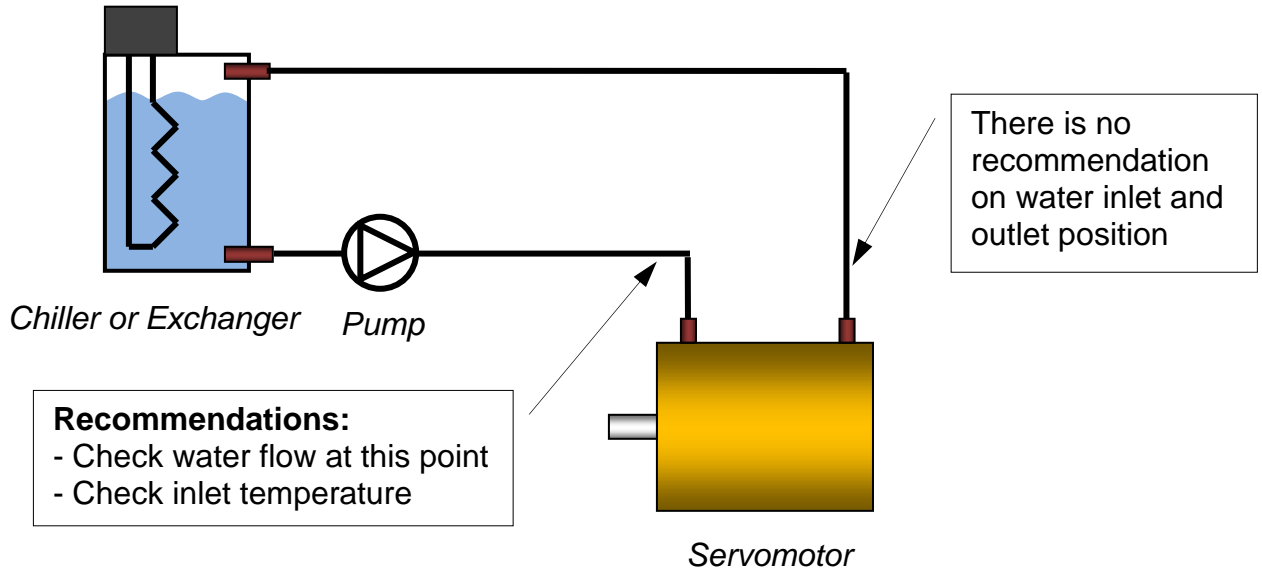

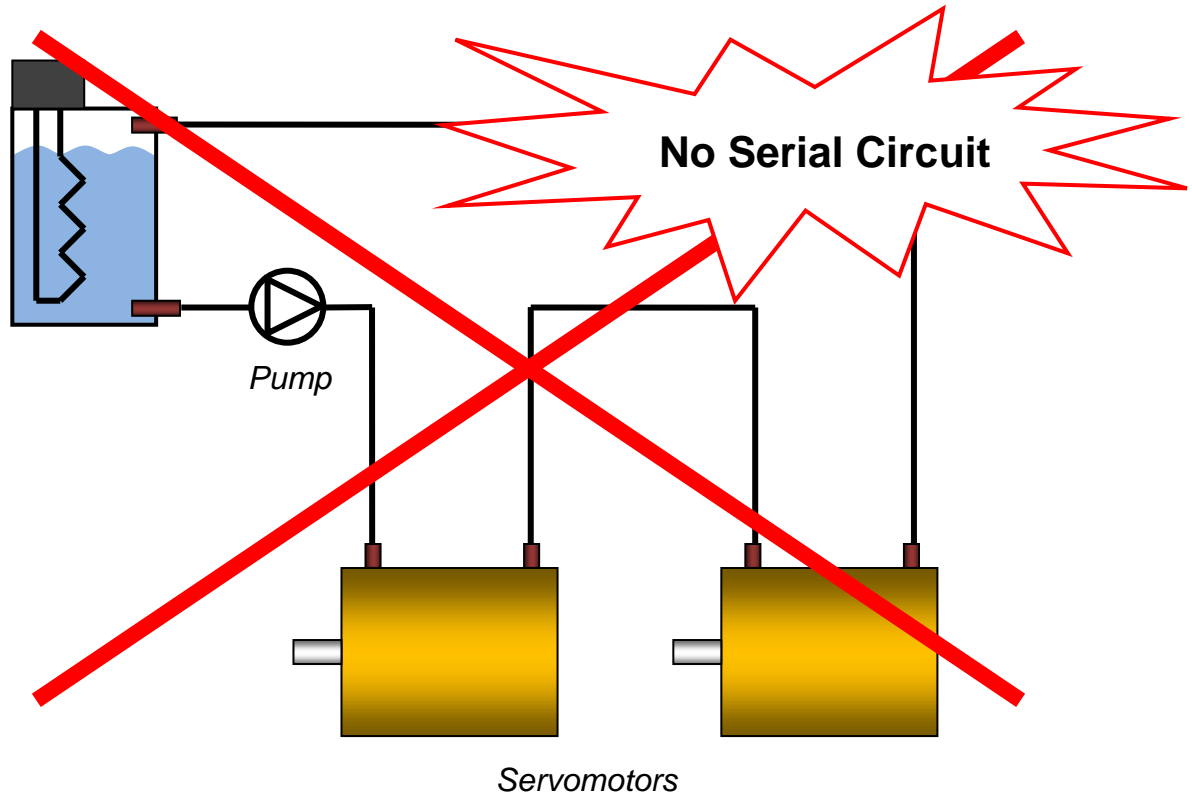
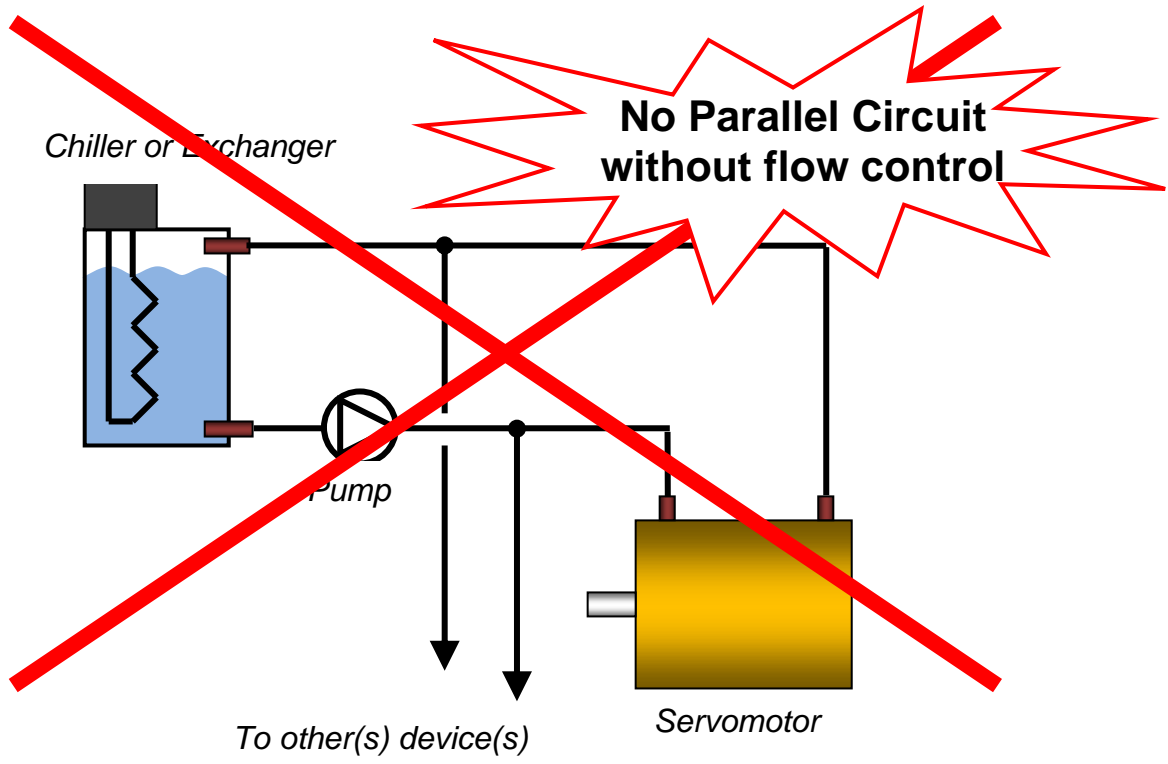

### 3.6. Thermal Protection

Different protections against thermal overloading of the motor are proposed as an option: Thermoswitch, PTC thermistors or KTY temperature built into the stator winding. No thermal protection are available for the NK1 motor

The thermal sensors, due to their thermal inertia, are unable to follow very fast winding temperature variations. They achieve their thermal steady state after a few minutes.



Warning: To protect correctly the motor against very fast overload, please refer to 3.1.6. Peak current limitations

#### 3.6.1. Alarm tripping with PTC thermistors :

One thermal probe (PTC thermistors) fitted in the NK servomotor winding trip the electronic system at  $150^{\circ} \pm 5^{\circ} \text{C}$  for class F version. When the rated tripping temperature is reached, the PTC thermistor undergoes a step change in resistance. This means that a limit can be easily and reliably detected by the drive.

The graph and tab below shows PTC sensor resistance as a function of temperature ( $T_N$  is nominal temperature)

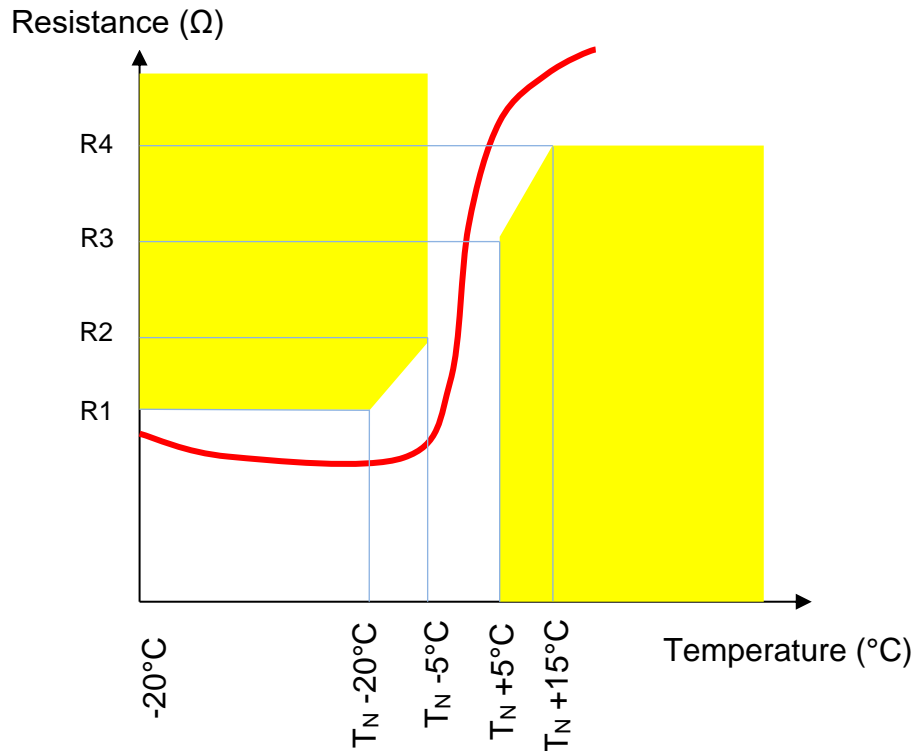

Temperature	Resistance value for NK2, NK6 and NK8	Resistance value for NK3 and NK4
-20°C up to $T_N-20^{\circ}\text{C}$	$R1 \leq 500\Omega$	$R1 \leq 750\Omega$
$T_N-5^{\circ}\text{C}$	$R2 \leq 1100\Omega$	$R2 \leq 1650\Omega$
$T_N+5^{\circ}\text{C}$	$R3 \geq 2660\Omega$	$R3 \geq 3990\Omega$
$T_N+15^{\circ}\text{C}$	$R4 \geq 8000\Omega$	$R4 \geq 12000\Omega$



### 3.6.2. Temperature measurement with KTY sensors:

Motor temperature can also be continuously monitored by the drive using a KTY 84-130 thermal sensor built in to the stator winding. KTY sensors are semiconductor sensors that change their resistance according to an approximately linear characteristic. The required temperature limits for alarm and tripping can be set in the drive.

The graph below shows KTY sensor resistance vs temperature, for a measuring current of 2 mA:

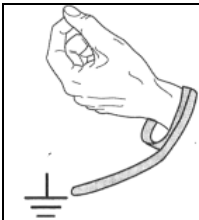
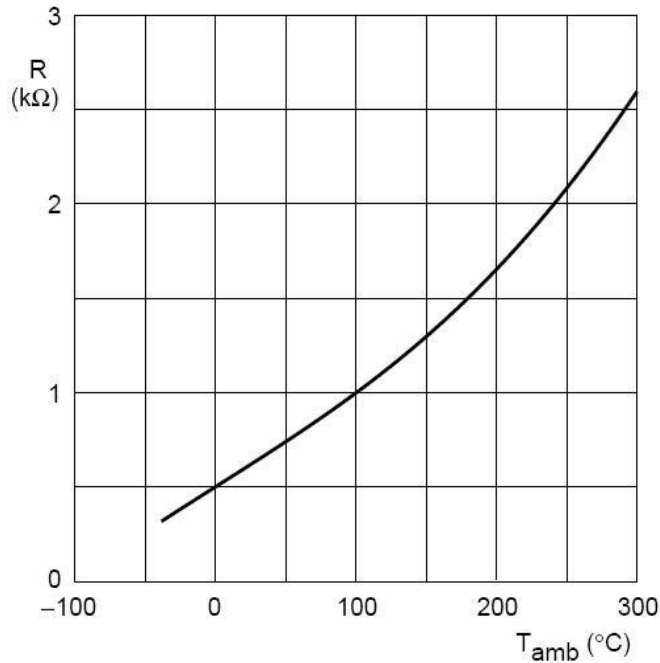

Warning: KTY sensor is sensitive to electrostatic discharge. So, always wear an antistatic wrist strap during KTY handling.



Warning: KTY sensor is polarized. Do not invert the wires.



Warning: KTY sensor is sensitive. Do not check it with an Ohmmeter or any measuring or testing device.

### 3.7. Power Electrical Connections

#### 3.7.1. Wires sizes

	<p>In every country, you must respect all the local electrical installation regulations and standards.</p>
---	--

Not limiting example in France: NFC 15-100 or IEC 60364 as well in Europe.

	<p>Cable selection depends on the cable construction, so refer to the cable technical documentation to choose wire sizes</p>
---	--

	<p>Some drives have cable limitations or recommendations; please refer to the drive technical documentation for any further information.</p>
---	--

#### Cable selection

	<p>At standstill, the current must be limited at 80% of the low speed current <math>I_0</math> and cable has to support peak current for a long period. So, if the motor works at standstill, the current to select wire size is <math>\sqrt{2} \times 0.8 I_0 \cong 1,13 \times I_0</math>.</p>
---	--

#### Sizes for H07 RN-F cable, for a 3 cores in a cable tray at 30°C max

Section [mm <sup>2</sup> ]	I <sub>max</sub> [A <sub>rms</sub> ]
1.5	17
2.5	23
4	31
6	42
10	55
16	74
25	97
35	120
50	146
70	185
95	224
120	260
150	299
185	341
240	401
300	461



Example of sizes for H07 RN-F cable :

Conditions of use:

Case of 3 conductors type H07 RN-F: **60°C maximum**

Ambient temperature: 30°C

Cable runs on dedicated cables ways

Current limited to 80%\*I<sub>0</sub> at low speed or at motor stall.

Example:

I<sub>0</sub>=100 Arms

Permanent current at standstill : 80 Arms

Max permanent current in the cable = 113 Arms

Cable section selection = 35mm<sup>2</sup> for a 3 cores in a cable tray at 30°C max.

You also have to respect the Drive commissioning manual and the cables current densities or voltage specifications

**3.7.2. Conversion Awg/kcmil/mm<sup>2</sup>:**

Awg	kcmil	mm <sup>2</sup>
	500	253
	400	203
	350	177
	300	152
	250	127
0000 (4/0)	212	107
000 (3/0)	168	85
00 (2/0)	133	67.4
0 (1/0)	106	53.5
1	83.7	42.4
2	66.4	33.6
3	52.6	26.7
4	41.7	21.2
5	33.1	16.8
6	26.3	13.3
7	20.8	10.5
8	16.5	8.37
9	13.1	6.63
10	10.4	5.26
11	8.23	4.17
12	6.53	3.31
14	4.10	2.08
16	2.58	1.31
18	1.62	0.82
20	1.03	0.52
22	0.63	0.32
24	0.39	0.20
26	0.26	0.13

### **3.7.3. Motor cable length**

For motors windings which present low inductance values or low resistance values, the own cable inductance, respectively own resistance, in case of large cable length can greatly reduce the maximum speed of the motor. Please contact PARKER for further information.



Caution: It might be necessary to fit a filter at the servo-drive output if the length of the cable exceeds 25 m. Consult us.

### **3.7.4. Ground connection**



DANGER: For the safety, you need to connect stator to the ground. Consult local regulation to choose the cross section and to know resistance limits to check ground continuity between frame and ground wire.

### **3.7.5. Motor cable**

The motor cables are flexible, so cables can take any direction. The electrical connection on motor in kit version is realized by high performance cable. The motor cable section depends of the motor current level. Please refer to the outline drawing to know the cross section.



Caution: The motor cables are designed for high current density, so cable surface can reach temperatures exceeding 100°C.



Caution: The wiring must comply with the drive commissioning manual and with recommended cables.  
Caution: Section motor cable is lower than commissioning section cable between motor and drive due to high performance motor cable design. Do not take the same cable section than motor ones.



Attention: Do not mix feedback wires with motor wires to avoid EMI (electromagnetic interference). EMI risk to set default the drive. So, careful to separate resolver and motor wires.

### 3.8. Feedback system

An angular position sensor is often used to run the motor and it depends on the drive functionalities. A drive with a sensorless mode needn't a feedback system.

A classic position sensor is an encoder, but a resolver could be a lower cost and more robust alternative.

	<p>Attention: Do not mix feedback wires with motor wires to avoid EMI (electromagnetic interference). EMI risk to set default the drive. So, careful to separate resolver and motor wires.</p>
--	--

#### 3.8.1. Resolver

##### 3.8.1.1. Overview

A resolver is an angular position sensor. It is used to determine rotor position. Its signals are processed by the drive in order to control the stator currents, the speed and the position.

The resolver is a high precision device and must be wired and mounted with care.



##### 3.8.1.2. Example of resolver mounting

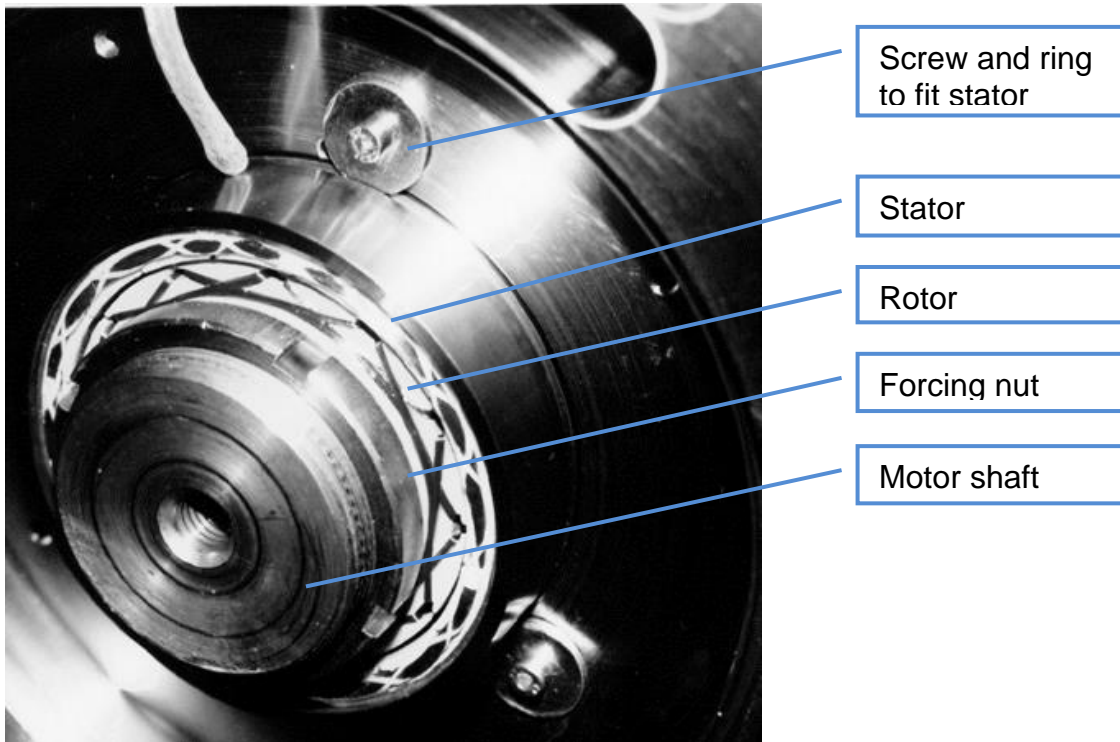

### 3.8.1.3. Resolver characteristics

Motor associated	NK3	NK4, NK6 & NK8	NK6 & NK8
Parker part number	220005P1001	220005P1002	220005P1003
Electrical specification	Values @ 8 kHz		
Polarity	2 poles		
Input voltage	7 Vrms		
Input current	86mA maximum		56mA maximum
Zero voltage	20mV maximum		
Encoder accuracy	$\pm 10'$ maxi		
Ratio	$0,5 \pm 5 \%$		
Output impedance (primary in short circuit whatever the position of the rotor)	Typical $120 + 200j \Omega$		Typical $95 + 180j \Omega$
Dielectric rigidity (50 – 60 Hz)	500 V – 1 min		
Insulation resistance	$\geq 100M\Omega$		
Rotor inertia	$\sim 30 \text{ g.cm}^2$		$\sim 123 \text{ g cm}^2$
Operating temperature range	-55 to +155 °C		

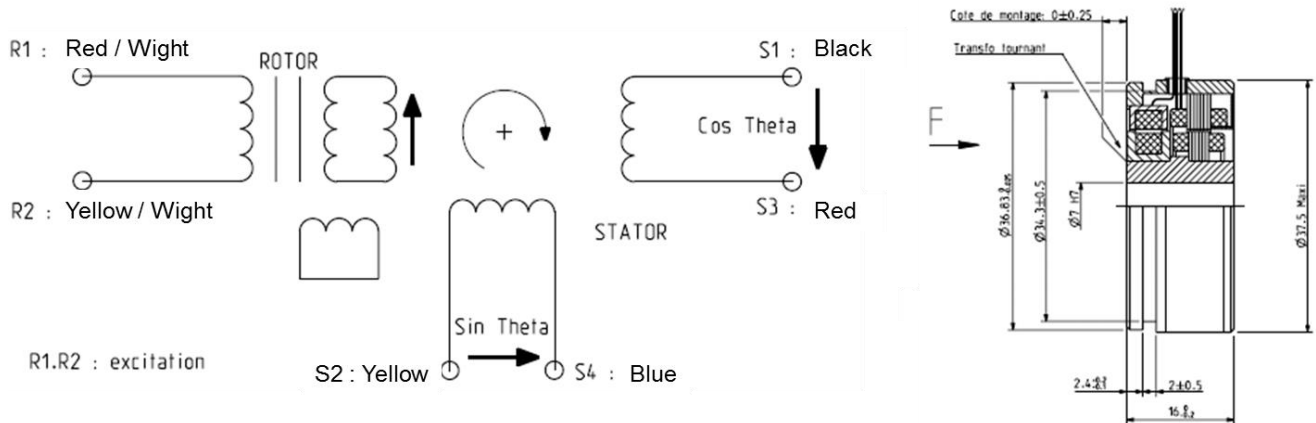

$S1 = \text{Cos} - \quad \left| \quad S2 = \text{Sin} - \quad \left| \quad R1 = \text{excitation} + \right. \right.$   
 $S3 = \text{Cos} + \quad \left| \quad S4 = \text{Sin} + \quad \left| \quad R2 = \text{excitation} - \right. \right.$

Rotor is clock wise rotation viewed from mounting flange end (F view)

	Resolvers are single pole pair resolvers: they give absolute position on 1 motor rotation.
	For easy motor integration and electrical checking a connector is recommended for the signals.

#### **3.8.1.4. Resolver setting**

During the setting procedure, it is strictly necessary to respect the 3 following conditions:

- The rotor must be able to rotate freely. The maximum friction torque on the rotor must not exceed 1% of the motor permanent torque.
- The cooling circuit has to be in use.
- The operator must be able to reach the resolver stator and to manually turn it and lock it (access to the locking screws).

Look at the drive instruction manual for the setting procedure details.

### Resolver part number 220005P1001

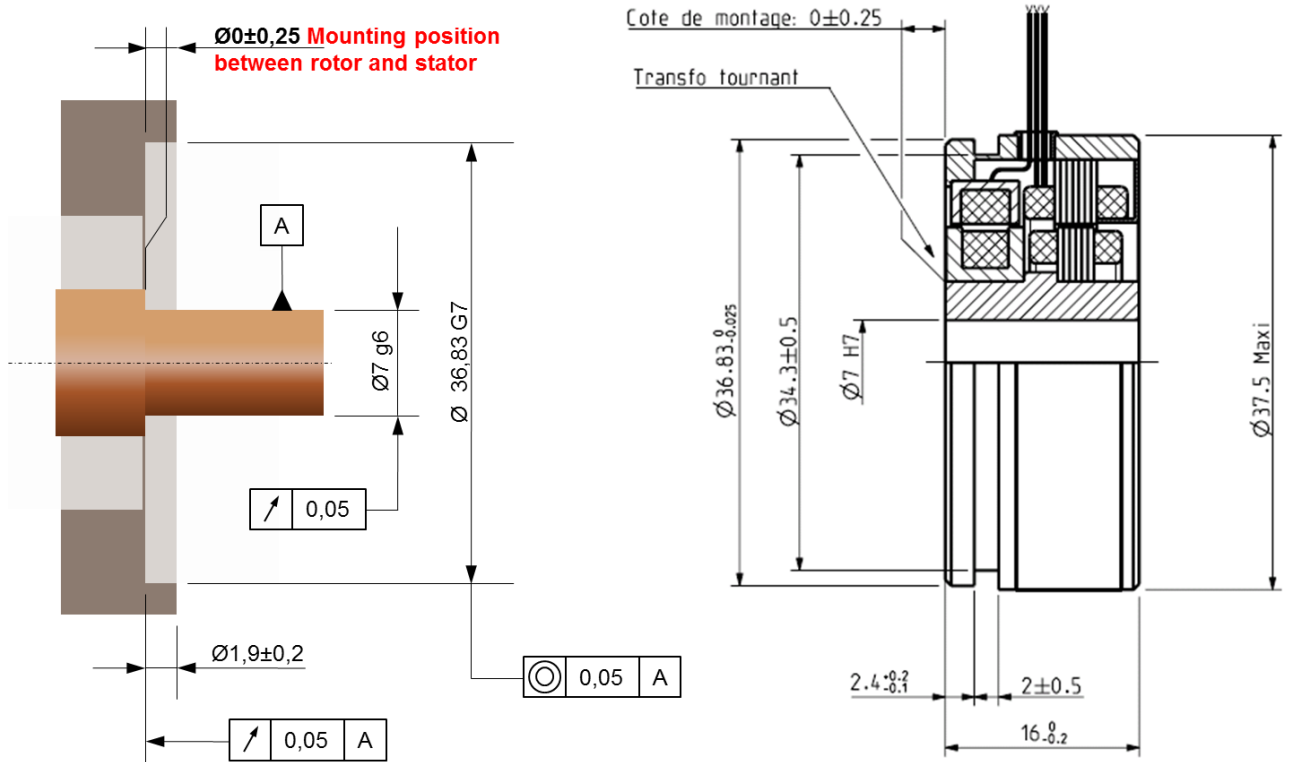

### Resolver part number 220005P1002

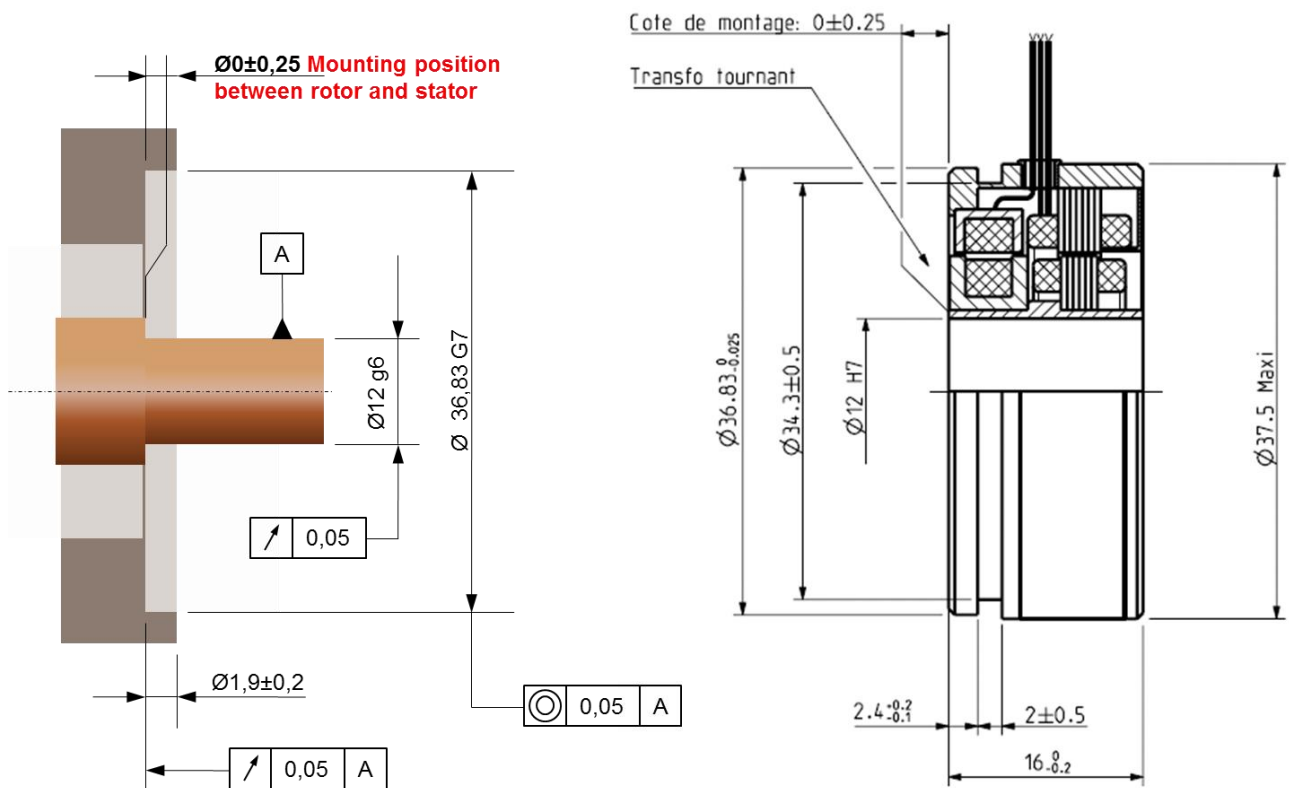



### Resolver part number 220005P1003

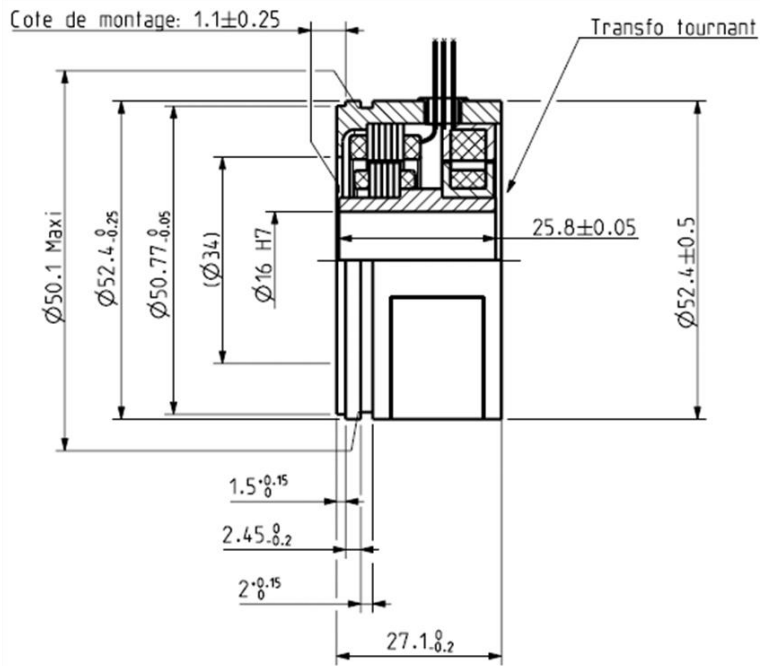
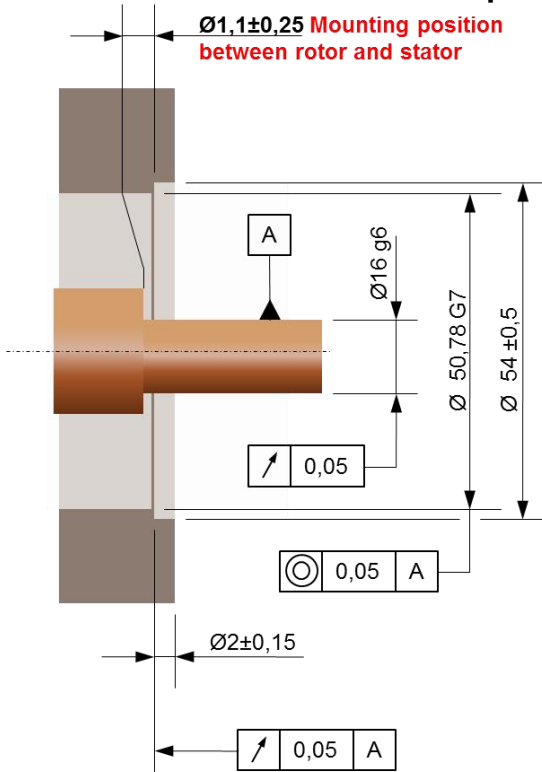

### 3.8.2. Encoder

Instead of a resolver we can provide an encoder:

- Incremental encoder
- incremental encoder with 10 poles commutations channels
- Hiperface single turn or multiturn
- Endat, single turn or multiturn
- ...



## 4. COMMISSIONING, USE AND MAINTENANCE

### 4.1. Instructions for commissioning, use and maintenance

#### 4.1.1. Equipment delivery

All servomotors are strictly controlled during manufacturing, before shipping. While receiving it, it is necessary to verify motor condition and if it has not been damaged in transit. Remove it carefully from its packaging. Verify that the data written on the label are the same as the ones on the acknowledgement of order, and that all documents or needed accessories for user are present in the packaging.



Warning: In case of damaged material during the transport, the recipient must **immediately** make reservations to the carrier through a registered mail within 24 h..

#### 4.1.2. Handling

Kit motors are delivered in two part, rotor and stator divided.







DANGER: Do not handle the stator with the help of electrical cables or use any other inappropriate method. Use non-magnetic material to handle rotor.

#### 4.1.3. Storage

Before being mounted, the motor has to be stored in a dry place, without rapid or important temperature variations in order to avoid condensation. During storage, the ambient temperature must be kept between -20 and +60°C. If the torque motor has to be stored for a long time, verify that the rotor and stator are coated with corrosion proof product.

## 4.2. Machine Integration

### 4.2.1. General warnings

	<p><u>Caution:</u> The integrator bears the entire responsibility for the preparation of the machine design.</p>
	<p><u>Danger :</u> The integrator must certify the motor by an approved organism to comply with all the regulations (CE, UL, ...) and perform all the mandatory routine tests (exemples : IEC60034...)</p>
	<p><u>Attention:</u> Rotor has strong permanent magnets. It creates strong attraction force that can crush fingers or hands. Firmly hold the rotor and move away all magnetic parts. <u>Caution:</u> Clean the working area of all ferromagnetic part such as tools, screws, steel particles. Use wood table to work or make machine assembly.</p>
	<p><u>Caution:</u> Anyone wearing pacemaker, hearing aid, watches, magnetic data storage device must keep at 1 meter from kit motor.</p>
	<p><u>Caution:</u> Before mounting the motor, the surface must be cleaned.</p>

The axial attraction force ( $F_a$ ) during the rotor insertion in the stator is:

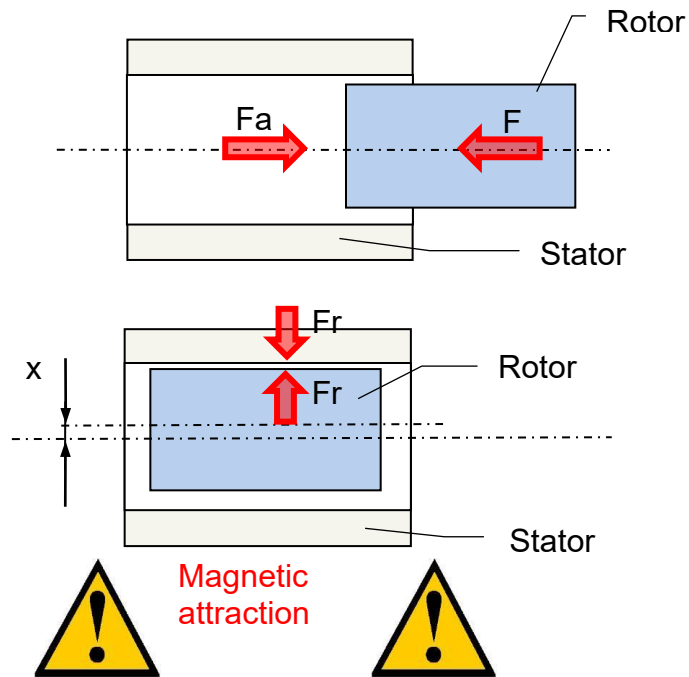

Radial attraction ( $F_r$ ) is proportional with axial offset ( $x$ ):

$$F_r(\text{N}) = K_r \cdot x(\text{mm})$$

Motor	$F_a$ N	$K_r$ N/mm	$X_{\text{max}}$ mm
NK310	33	1600	0.4
NK420	60	2000	0.4
NK430	60	3000	0.4
NK620	83	3000	0.4
NK630	83	4500	0.4
NK820	121	3330	0.5
NK840	121	6660	0.5
NK860	121	10000	0.5

#### 4.2.2. Tightening torque

The table below gives the average tightening torques required regarding the fixing screw diameter. These values are valid for both motor's feet and flange bolting.

Screw diameter	Tightening torque
M2 x 0.35	0.35 N.m
M2.5 x 0.4	0.6 N.m
M3 x 0.5	1.1 N.m
M3.5 x 0.6	1.7 N.m
M4 x 0.7	2.5 N.m
M5 x 0.8	5 N.m
M6 x1	8.5 N.m
M7 x 1	14 N.m
M8 x 1.25	20 N.m

Screw diameter	Tightening torque
M9 x 1.25	31 N.m
M10 x 1.5	40 N.m
M11 x 1.5	56 N.m
M12 x 1.75	70 N.m
M14 x 2	111 N.m
M16 x 2	167 N.m
M18 x 2.5	228 N.m
M20 x 2.5	329 N.m
M22 x 2.5	437 N.m
M24 x 3	564 N.m



Warning: After 15 days, check all tightening torques on all screw and nuts.

### 4.2.3. Rotor integration step by step

#### Step 1

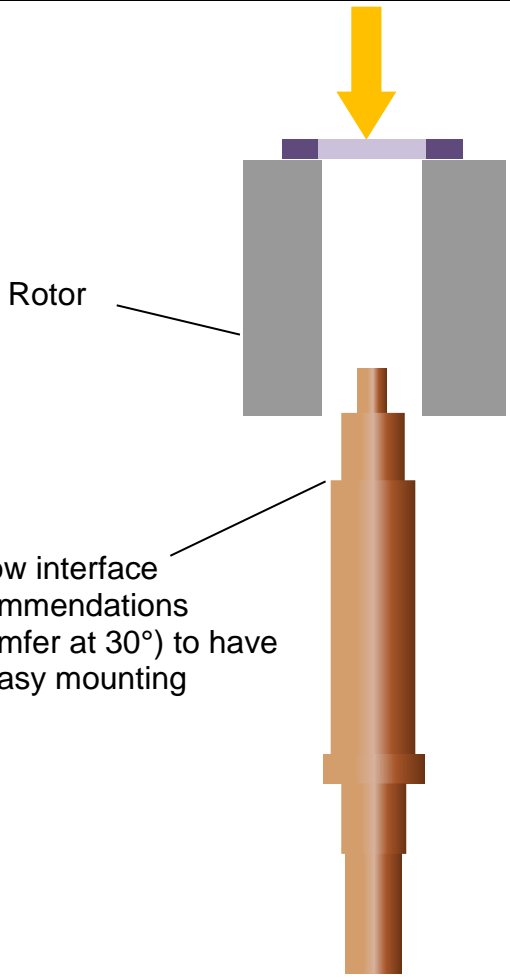

Push down the rotor on the shaft with a press. Maximum press force is described in §3.4.4.1.  
Make sure you have followed the shaft interface instruction (see §3.4.4.1).

Step 2

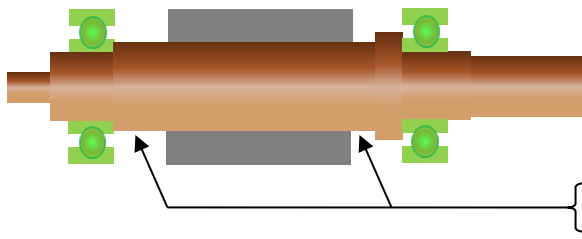

Rotor balancing is an option and depend on speed application.  
For high speed application, rotor must be balanced with bearings and shaft.

Balancing recommended level : G2.5

Area to add or remove material to balance rotor

Rotors are not balanced before delivery. The electro-spindle manufacturer must balance the complete spindle rotor (shaft, bearings and rotor) using an appropriate method: for example, by removing or add material from shaft.



Caution: In case of drilling, be careful about shaving of metal with magnetic part.  
We recommend to add material (screws)



Caution: Balancing must never be made by removing material from the rotor sides, the rotor lamination or any other part of the rotor.



### 4.2.1. Natural cooled stator integration step by step

Step 1	
	Increase the housing temperature to 250°C to 300°C

Step 2	
<p>Chamfer at 30° to have an easy mounting</p>	<p>Push down the stator in the water jacket.</p> <p>Make sure you have followed the housing interface instruction (§3.4.2.2).</p>

Step 3

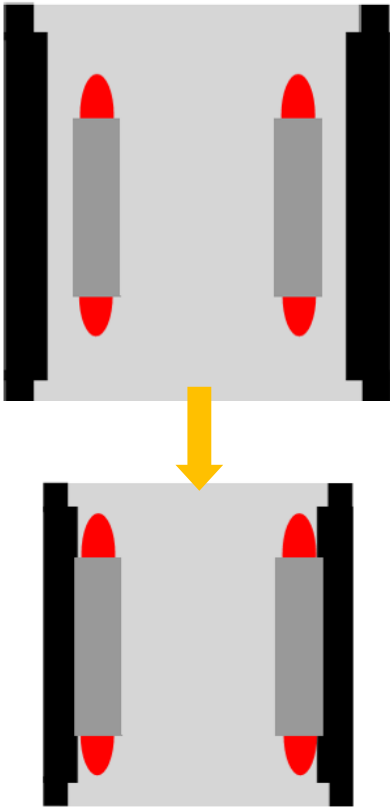

After fitting, let stator+housing go back to ambient temperature

**4.2.2. Water cooled stator integration step by step**

Step 1

O-Ring seal

Water jacket with water circuit

Assemble O-Ring seal on water jacket.

O-Ring information's for standard water jacket in chapter "O-Ring specification" (§3.4.5.1).

Step 2

Cooling jacquet

Water jacket with water circuit

Prepare the cooling jacket for his integration :

**Water inlet and outlet must be aligned with the cables inlet**

Make sure you have followed the cooling jacket interface instructions.

The 4 O-rings must be greased with an ordinary lubricant before mounting to avoid damages and leakages

### 4.2.3. Motor integration

Rotor assembly into stator

There are different solutions, depends of the weight of the rotor:

-1<sup>st</sup> solution: for light motor

Step 1	
<p>Clean workbench – no magnet part</p>	<p>Screw the stator onto the front flange.</p> <p>Put the stator onto workbench.</p> <p>Put spring ring.</p> <p>Prepare rotor : fit onto rear flange.</p>
Step 2	
<p><b>Tooling :</b> Guide is an extra shaft</p> <p>Adjusted – H7 / g6</p>	<p>For an easier assembly, use an extra shaft to guide rotor on stator to avoid gluing due to magnetic parts.</p>

Step 3

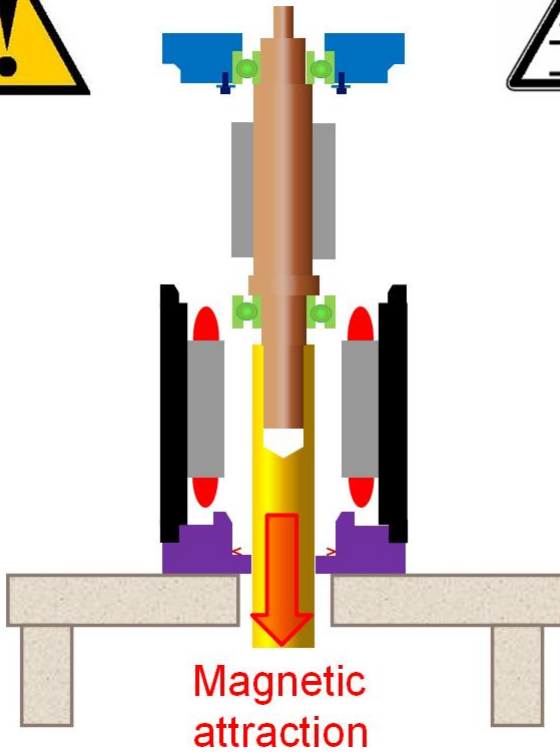

Danger : do not put your hand inside the motor during way-down.

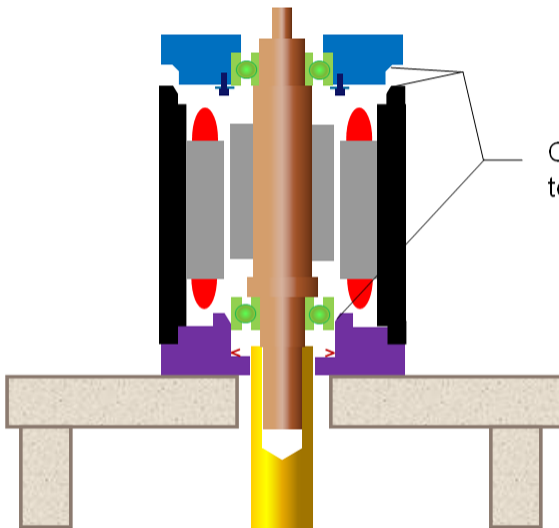

Chamfer at 30° to have a easy mounting

Make sure you have done chamfers at 30°.

Step 4

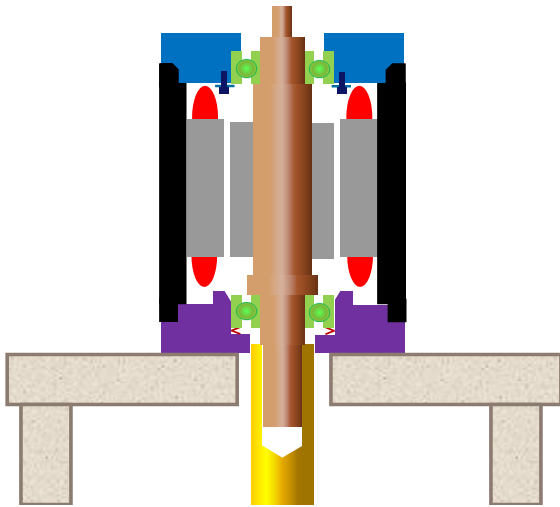

Screw the rear flange on the stator to close motor.

Step 5

Last step is the encoder or resolver mounting



Caution: After 15 days, check all tightening torques on screws and nuts

-2<sup>nd</sup> solution : for heavy motor

Step 2

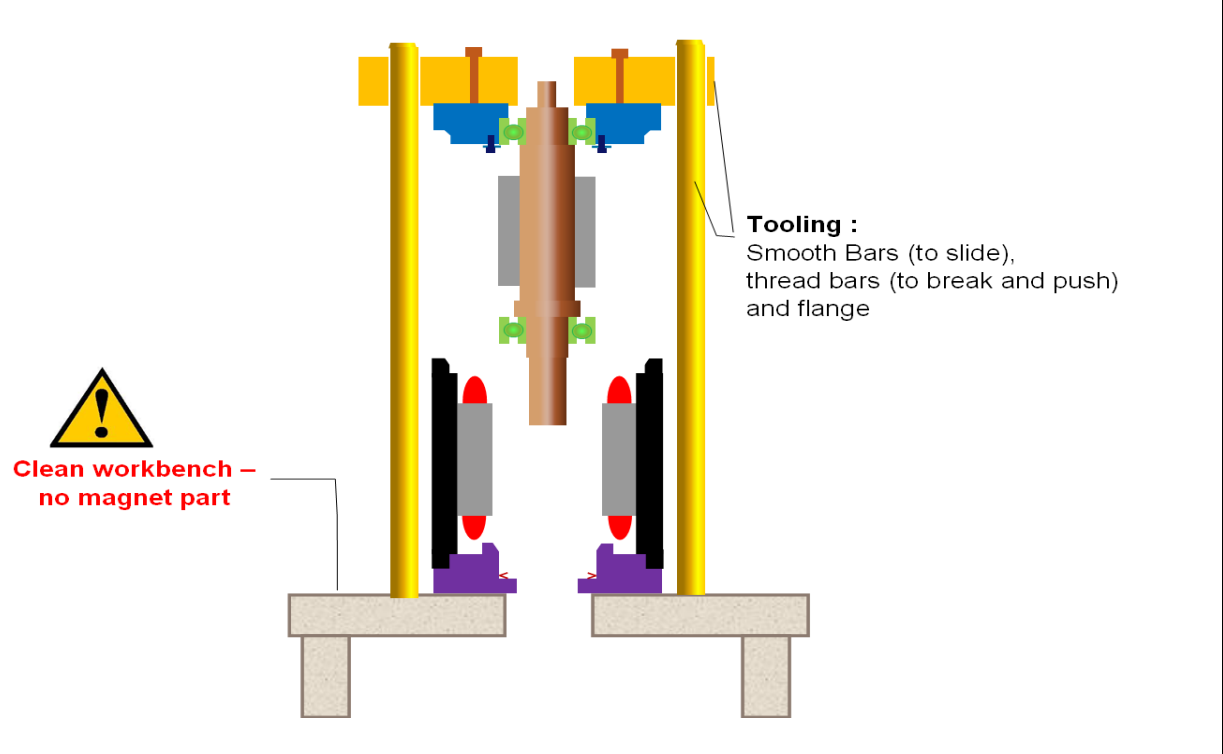

For an easier assembly, use extra smooth and thread bars outside of the stator to guide and push rotor onto the stator.

Step 4

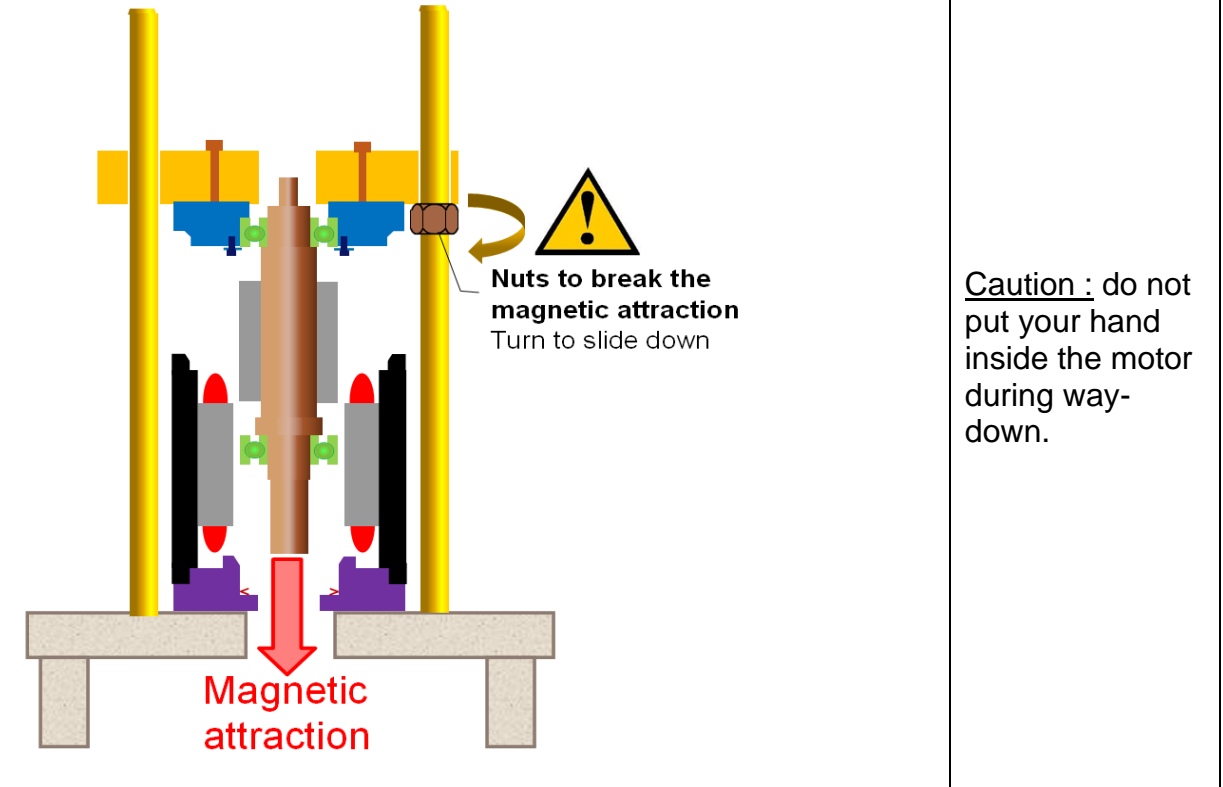

**Caution :** do not put your hand inside the motor during way-down.

Step 5

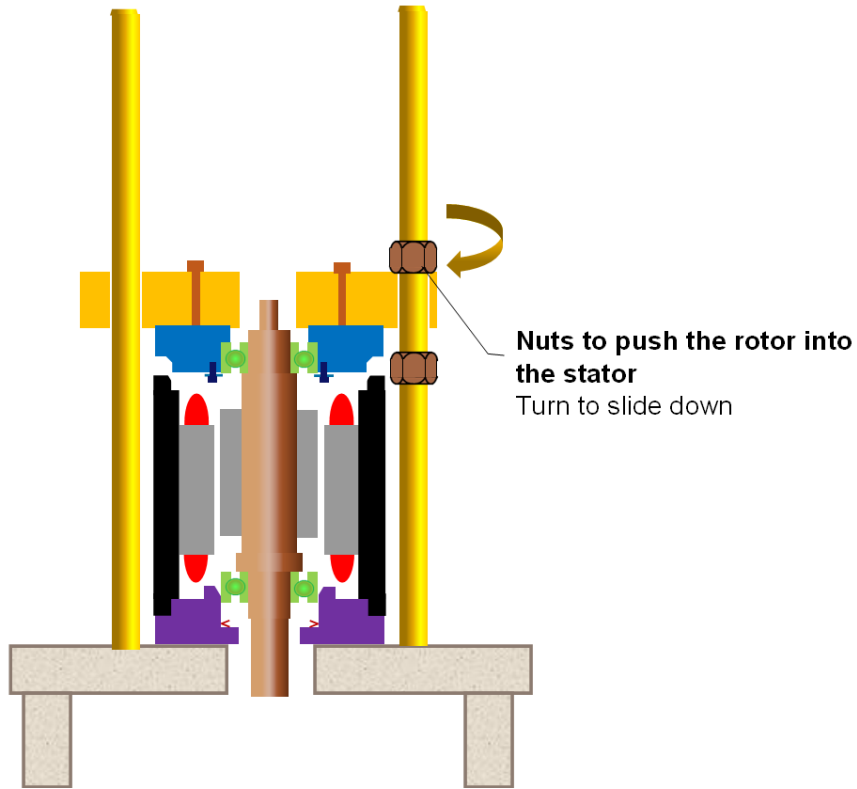

Make sure the rotor is well setting up in place.

Step 6

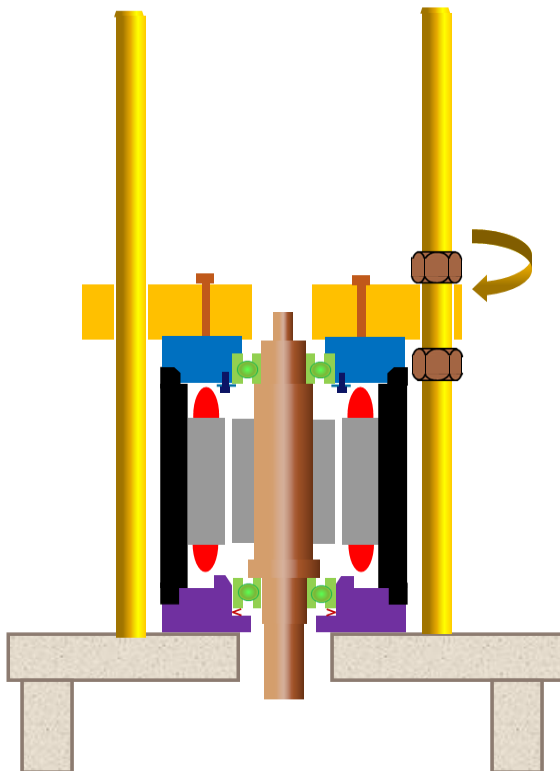

Unscrew the mobile flange onto the rear flange.

Fit rear flange.



Step 7

Last step is the encoder or resolver mounting



Caution: After 15 days, check all tightening torques on screws and nuts

### 4.3. Resolver mounting



**Caution:** The resolver is a high precision, carefully manufactured device and the following precautions should be taken to maintain its characteristics:

- ⇒ avoid shocks
- ⇒ avoid impact between rotor and stator.
- ⇒ do not hold the stator by its cables
- ⇒ Do not mismatch the rotor, stator and resolver.
- ⇒ Connect the resolver according to the drive user manual.
- ⇒ The resolver is not watertight. Protect it against oil spray.



**Attention:** Do not mix resolver wires with motor wires to avoid EMI (electromagnetic interference). EMI risk to set default the drive. So, careful to separate resolver and motor wires.

#### 4.3.1. Mounting step by step

Check the mounting position between rotor and stator and adjust with rings

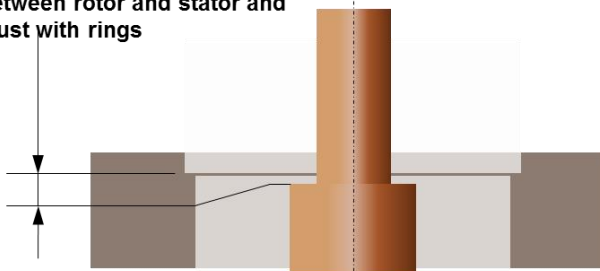

Adjust with rings

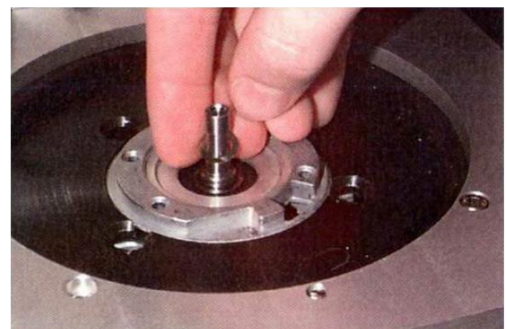
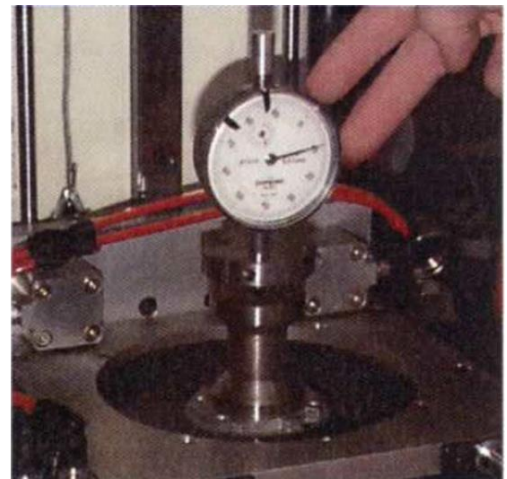
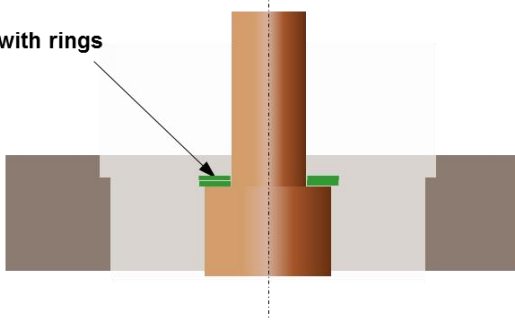

Put the resolver rotor

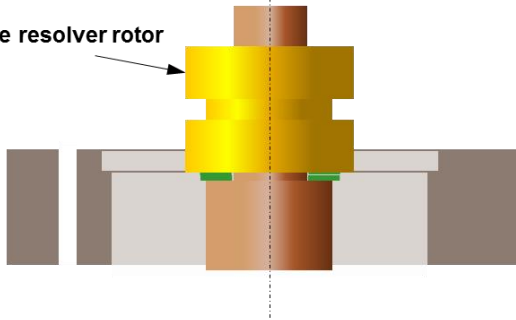

Fit the resolver stator

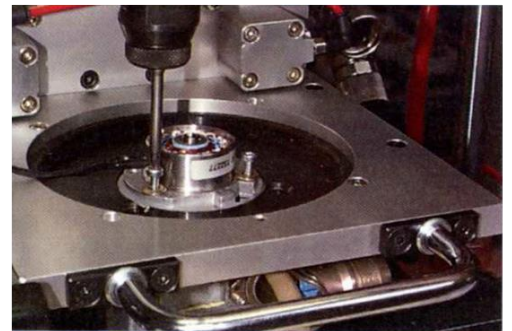
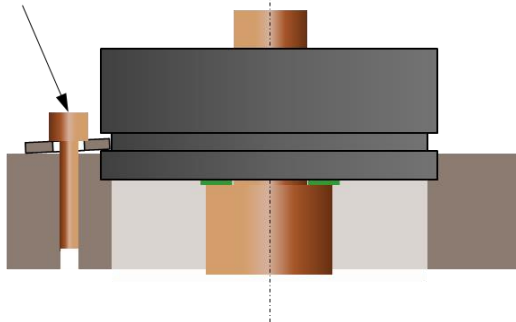







#### **4.3.2. Setting of the resolver**

At the time of the procedure of setting, it is imperative to observe the 3 following conditions:

- The motor rotor must be free in rotation. The torque of maximum friction on the rotor should not exceed 1 % of torque permanent motor.
- The coolant cooling system must be under operation.
- The operator must have access to the resolver stator and be able to turn it manually and then lock it in place (with lock screw).

To refer to the drive manuals, for the details of the setting procedure.

## 4.4. Electrical connections

	<p><u>Danger:</u> Do not connect the kit to any electric supply . Only the motor can be connected to an electric supply.</p>
	<p><u>Danger:</u> Check that the power to the electrical cabinet is off prior to making any connections.</p>
	<p><u>Caution:</u> The wiring must comply with the drive commissioning manual and with recommended cables. <u>Caution:</u> Section motor cable is lower than commissioning section cable between motor and drive due to high performance motor cable design. Do not take the same cable section than motor.</p>
	<p><u>Danger:</u> The servomotor must be earthed by connecting to an unpainted section of the motor.</p>
	<p><u>Caution:</u> The motor cables are designed for high current density, so cable surface can reach temperatures exceeding 100°C.</p>
	<p><u>Caution:</u> After 15 days, check all tightening torques on cable connection.</p>

Please, read §3.7 "Electrical connection" to have information about cable. Many useful informations are already available in the drive documentations.

The motor must be connected to the servo amplifier according to the drive user manual. The color code given in the table must be followed :

Signal	Color
U	Black
V	White
W	Red



The motor is shipped without a ground cable. It is mandatory to connect a (green-yellow) ground cable between the motor frame and machine. The ground cable cross-section must be the same as the power cable cross-section

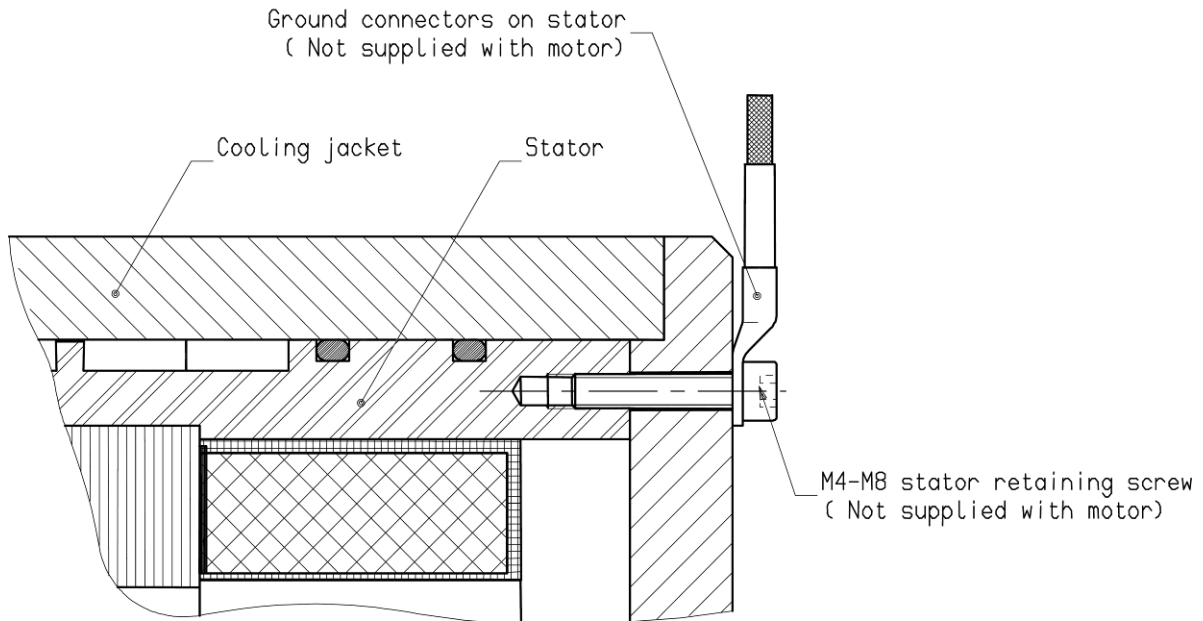



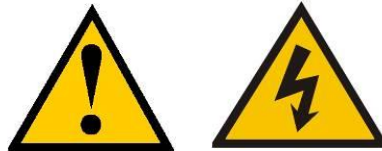

Before applying power:



- ✓ Check there is no damage on winding or cable due the mounting by a dielectric test
- ✓ Check all external wiring circuits of the system – power, control, motor and earth connections.
- ✓ Ensure that nobody is working on another part of the system who will be affected by powering up
- ✓ Ensure that other equipment will not be adversely affected by powering up.

## 4.5. Encoder cable handling

	<p><u>Danger:</u> before any intervention the drive must be stopped in accordance with the procedure.</p>
	<p><u>Caution:</u> It is forbidden to disconnect the Encoder cable under voltage (high risk of damage and sensor destruction).</p>
	<p><u>Attention:</u> Do not mix feedback wires with motor wires to avoid EMI (electromagnetic interference). EMI risk to set default the drive. So, careful to separate resolver and motor wires.</p>
	<p><u>Warning:</u> Always wear an antistatic wrist strap during encoder handling.</p>
	<p><u>Warning:</u> Do not touch encoder contacts (risk of damage due to electrostatic discharges ESD).</p>

## 4.6. Tests

The motor components delivered by Parker are tested :

- dielectric test,
- surge test,
- winding resistance and inductance,
- direction of rotation,
- rotor flux.

**But complete motor must be tested for safety reason and to comply with the regulations (CE,...).**

	<p><b>Danger</b> : The integrator must certify the motor by an approved organism to comply with all the regulations (CE, UL, ...) and perform all the mandatory routine tests (exemples : IEC60034...).</p> <p>The typical process is the qualification of a complete unit and routine tests (including safety tests) on each unit produced</p>
---	---

**Exemple of a summary of the recommended safety tests, to be validated bu an approved organism.**

**Attention : other could be needed in accordance with regulations:**

- **The continuity of the grounding circuit :**

On **each** complete unit, the resistance between any conductive point and the grounding conductor shall not exceed than 100mΩ. This test shall be performed before the dielectric tests. (EN60204-1: Safety of the machine)

- **Below exemples of dielectric tests performed on each complete unit (Sefelec SMG50 can be used) for a 400V supply :**

Dielectric Test	Motor U,V,W wires	Thermal sensor wires	Brake wires	Resolver wires	Frame	Test duration, depends on power
Motor	1800V for 400 V	Connected on Frame	Connected on Frame	Connected on Frame	0V	1min
Thermal sensor	Connected on Frame	1500V	Connected on Frame	Connected on Frame	0V	1min
Resolver	Connected on Frame	Connected on Frame	Connected on Frame	620V	0V	1s
Brake	Connected on Frame	Connected on Frame	500V	Connected on Frame	0V	1min
Encoder	Check with encoder supplier for tests to be done					
...	...					

## 4.7. Troubleshooting

Some symptoms and their possible causes are listed below. This list is not comprehensive. Whenever an operating incident occurs, consult the relevant servo drive installation instructions (the troubleshooting display indications will help you in your investigation) or contact us at: <http://www.parker.com/eme/repairservice>.

<p>You note that the motor does not turn by hand when the motor is not connected to the drive.</p>	<ul style="list-style-type: none"> <li>• Check there is no mechanical blockage or if the motor terminals are not short-circuited.</li> <li>• Check the power supply to the brake</li> </ul>
<p>You have difficulty starting the motor or making it run</p>	<ul style="list-style-type: none"> <li>• Check on the fuses, the voltage at the terminals (there could be an overload or the bearings could be jammed), also checks on the load current.</li> <li>• Check the power supply to the brake (+ 24 V ± 10 %) and its polarity.</li> <li>• Check on any thermal protection, its connection and how it is set in the drive.</li> <li>• Check on the servomotor insulation (if in doubt, carry out hot and cold measurements).</li> </ul> <p>The minimum insulation resistance value measured under a max. 50V DC is 50 MΩ:</p> <ul style="list-style-type: none"> <li>• Between the phase and the casing</li> <li>• Between the thermal protection and the casing</li> <li>• Between the brake coil and the casing               <ul style="list-style-type: none"> <li>- Between the resolver coils and the casing.</li> </ul> </li> </ul>
<p>You find that the motor speed is drifting</p>	<ul style="list-style-type: none"> <li>• Reset the offset of the servoamplifier after having given a zero instruction to the speed setpoint input.</li> </ul>
<p>You notice that the motor is racing</p>	<ul style="list-style-type: none"> <li>• Check the speed set-point of the servo drive.</li> <li>• Check you are well and truly in speed regulation (and not in torque regulation).</li> <li>• Check the encoder setting</li> <li>• Check on the servomotor phase order: U, V, W</li> </ul>
<p>You notice vibrations</p>	<ul style="list-style-type: none"> <li>• Check the encoder and tachometer connections, the earth connections (carefully) and the earthing of the earth wire, the setting of the servo drive speed loop, tachometer screening and filtering.</li> <li>• Check the stability of the secondary voltages.</li> <li>• Check the rigidity of the frame and motor support.</li> </ul>
<p>You think the motor is becoming unusually hot</p>	<ul style="list-style-type: none"> <li>• It may be overloaded or the rotation speed is too low : check the current and the operating cycle of the torque motor</li> <li>• Check if the mounting surface is enough or if this surface is not a heat source – see §3.5 cooling.</li> <li>• Friction in the machine may be too high :               <ul style="list-style-type: none"> <li>- Test the motor current with and without a load.</li> <li>- Check the motor does not have thermal insulation.</li> </ul> </li> </ul>



You find that the motor is too noisy	Several possible explanations : <ul style="list-style-type: none"><li>• Unsatisfactory mechanical balancing</li><li>• There is friction from the brake: mechanical jamming.</li><li>• Defective coupling</li><li>• Loosening of several pieces</li><li>• Poor adjustment of servo drive or position loop : check rotation in open loop</li></ul>
The motor is warmer on its top	Air bubbles can be stocked in the water cooling circuit. You need to purge the circuit or to double the water flow rate during 10 minutes to remove the air bubbles.